



LOOK UP

TO GREAT DESIGNS | TO WIDE RANGE | TO ENERGY SAVINGS



LOOK UP

TO GREAT DESIGNS | TO WIDE RANGE | TO ENERGY SAVINGS



CEILING FAN INNOVATION:

**BETTER COOLING,
SMARTER WARMING**

FLORETTE BLDC

ALL WEATHER UNDERLIGHT



INDUSTRIAL

VENTIL-AIR

PEDESTAL

LIFESTYLE

WALL

TABLE

REGULAR

DECORATIVE

KIDS

SPECIAL FINISH

UNDERLIGHT ENERGY SAVING

BLDC+

BLDC+ UNDERLIGHT

FAN PLANT

Havells has installed world class manufacturing plant which is India's most modern and integrated unit for electric fans in the country. Located in Haridwar, Uttarakhand, the plant is equipped with state-of-the-art technology including automated CNC machines for motor winding and other operations, advanced conveyor assembly lines complete with computerized testing facilities for 100% fans. The company keeps upgrading its facilities constantly, to be in line with the ever-changing market dynamics.

Let the wide range of Havells Fans bring in a new change and add value to your lifestyle.

Haridwar, Uttarakhand



ABOUT US

Redefining the modern homes with innovation and excellence

Havells is at the forefront of transforming modern living spaces by offering innovative solutions that elevate everyday experiences. With a deep understanding of consumer needs, the company has expanded its footprint across every aspect of home life, creating environment that are not only functional but also comfortable, stylish and future-ready. To make these solutions accessible, Havells leverages an extensive distribution network encompassing 18,000 dealers, over 1,000 exclusive brand stores, intensifying presence in modern retail, e-commerce and quick commerce.

The company's portfolio includes power brands like Havells, Havells Crabtree, Lloyd, REO, Havells Studio and Standard each designed to cater to the unique demands of today's consumers.

Anchored in the 'Make in India' initiative, Havells operates 16 cutting-edge manufacturing facilities across India, producing 90% of its products in-house. At the forefront of Havells product evolution lies its Customer Experience & Designs (CXD) Studio, where creativity and user-centric design converge. This is complemented by its Centre for Research & Innovation (CRI), supported by four advanced R&D centres, enabling Havells to consistently deliver products that are both functional and visually compelling.

Driven by a commitment to innovation, quality and design, the company also upholds sustainable practices throughout its operations, including eco-friendly manufacturing processes and energy-efficient product design, contributing to a greener and more sustainable future.



CORPORATE OFFICE, NOIDA



State-of-the-Art Manufacturing Unit



Customer Experience & Design



Industry 4.0 Process



Center For Research & Innovation



16 Manufacturing Units

~18000 Strong Dealer Network

4 Research Centres

48 Offices



PURITY FOR SURETY

HIGH STRENGTH

Stronger than aluminium

HIGH PERFORMANCE

Almost twice the current carrying capacity vs aluminium

HIGH STABILITY

Copper is non-reactive to Water, not susceptible to Oxidation and unaffected by Temperature changes

HIGH DUCTILITY

Can be drawn into very thin wires, easier to solder, very high flexibility, hence easy to install and repair

AWARDS AND RECOGNITION

ENTICER

**INDIA DESIGN
MARK AWARD**

2017

STEALTH AIR

**CII DESIGN
EXCELLENCE
AWARD**

2018

STEALTH AIR

**INDIA DESIGN
MARK AWARD**

2018

EFFICIENCIA NEO

**NATIONAL
ENERGY
CONSERVATION
AWARD**

2021

AMAYA

**PRODUCT
OF THE YEAR**

2023

HAWA BADLEGI

**MARKETING
EXCELLENCE
AWARD**

2023

HAVELLS

**TOP 50 BEST
INDIAN
BRANDS**

2023

GANPATI
HOARDING

**BEST
ADVERTISING
AWARD**

2023

AMAYA

**GERMAN
DESIGN AWARD**

2024

ALBUS
UNDERLIGHT

**PRODUCT
OF THE YEAR**

2024

COMPREHENSIVE FAN SELECTION GUIDE

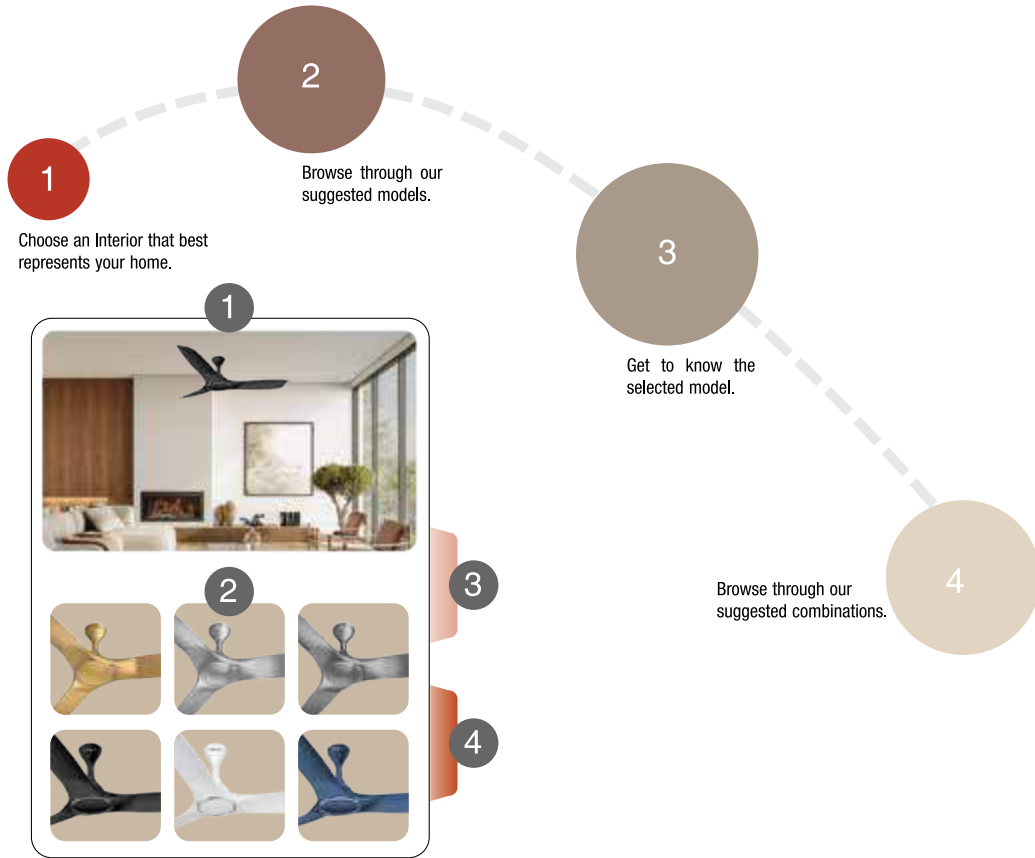

THE TECHNICAL KNOW-HOWS ?

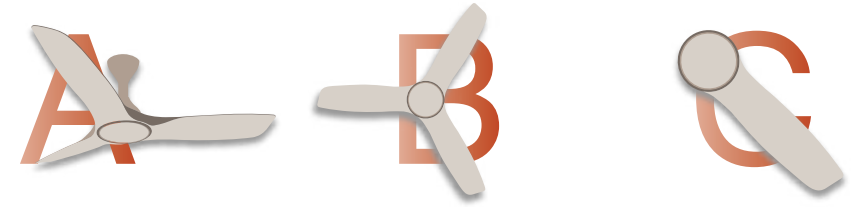

A

Sellers may use "Sweep Size" and "Fan Diameter" interchangeably to describe ceiling fan dimensions.

Choosing the appropriate size is crucial for maximizing air circulation efficiency and minimizing energy usage.

B

Having multiple blades doesn't guarantee more cooling/ air circulation. Fan blades are designed to provide more air or less air circulation based on the type of fan/ model.

More blades gives off a "traditional" vibe while fewer blades give an "advanced" appearance.

C

Do not rely solely on the number of blades or RPM. Instead, consider the fan's Air Delivery (AD) value, listed in the technical specifications. This measurement indicates the fan's actual airflow capacity, ensuring you choose the right fan for your room's size and ventilation needs. A higher AD value signifies better airflow and circulation.

HINTS FOR QUICK AND PLEASING RESULTS

CHOOSING COLORS

Match the color of the fan to suite the ceiling and furniture for a balanced look. Choosing a dark colored fan can accentuate your ceiling, while light colored fans will make the room look silent.

Modern interiors are best paired with solid colored BLDC fans for a smart look.

Traditional homes shines well with deco trims and prints on fan blades/ show cap.

Monochrome fans adds an elegant look in brightly lit/ colored spaces.

TYPE OF ROOM

Dusty Rooms require constant maintenance. Choose Liquid paint with anti-duct coating.

Quiet spaces such as work rooms need silent fans preferably with an under light feature.

Stagnant Spaces

Smart Spaces look better with slim fans with under light/ UI panels for a smart look.

FAN SELECTION GUIDE

INSTALLATION GUIDE

DETERMINING IDEAL FAN NUMBERS BASED ON SWEEP SIZES

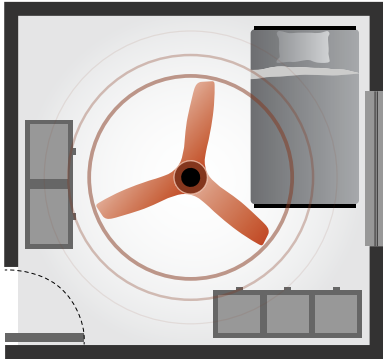

Linear room layout

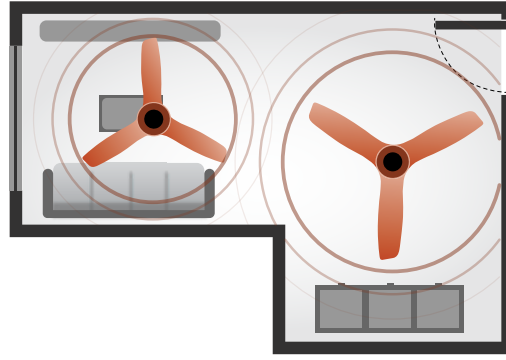

Non-Linear room layout

SWEEP SIZES CHART

SWEEP SIZE	ROOM SIZE	ROOM TYPE
600 mm	1.2 m x 2 m	Small Cabin, Utility, Veranda, Balcony, Washroom, etc.
1050 mm	3 m x 3 m	Guest Bedroom, Drawing Room, etc.
1200 mm	3.6 m x 4 m	Master Bedroom, Living room, Dining Hall, etc.
1400 mm	4.2 m x 4.8 m	Large Halls, Work Space, etc.

OPTIMAL HEIGHT BETWEEN FLOOR AND CEILING FAN

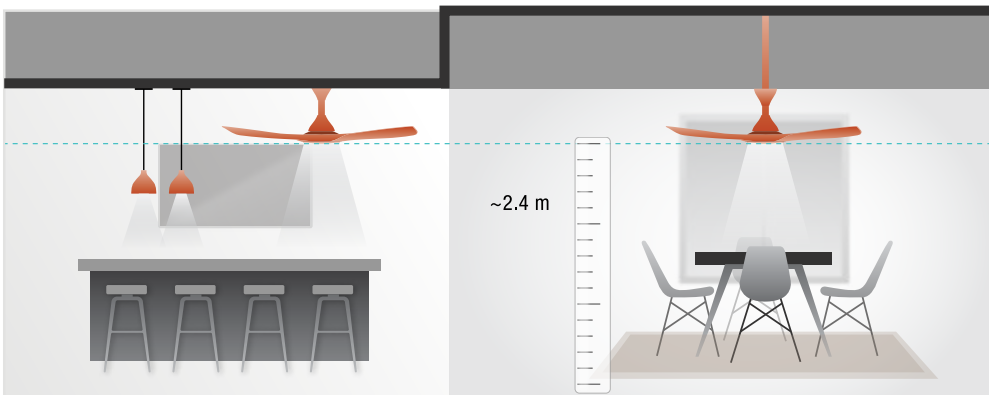

STAR RATING SYSTEM

You may notice images and stickers indicating the BEE Star Rating (service value) of the product on the above zones on our Fans and Packaging, to help you make informed decisions on your purchase.

$$\text{Service Value} = \frac{\text{Air Delivery (m}^3/\text{min)}}{\text{Wattage (W)}}$$



FOLLOWING ARE THE MINIMUM SERVICE VALUE OFFERED BY HAVELLS FOR DIFFERENT SWEEP SIZES.

FAN SWEEP SIZE	MINIMUM AIR DELIVERY	MINIMUM SERVICE VALUE
600 mm	100 m ³ /min	1.5
1050 mm	210 m ³ /min	4.0
1200 mm	220 m ³ /min	4.0
1400 mm	240 m ³ /min	4.3

ENERGY EFFICIENCY AND SAVINGS

	NO RATING	1 STAR	2 STAR	3 STAR	4 STAR	5 STAR
Electricity Bill Per Annum	₹ 2 850.00	₹ 2 000.00	₹ 1 775.00	₹ 1 600.00	₹ 1 450.00	₹ 1 325.00
Annual Savings* Compared to "No Rating"		₹ 850.00	₹ 1 075.00	₹ 1 250.00	₹ 1 400.00	₹ 1 525.00

*Energy conservation as compared with conventional non star rated fans

LOOK UP TO STEALTH VOICE BLDC+ FAN

+  **DIRECT VOICE COMMAND**
NO WIFI REQUIRED



Hello Havells!
Switch On The Fan

 NO BLUETOOTH |  NO SMART PHONE



UPTO 65%*
ENERGY SAVINGS

Range of Voice Command fans are available

*Energy conservation as compared with conventional non star rated fans

LOOK UP TO CRISTA UNDERLIGHT BLDC+ FAN

+  **DUAL UNDERLIGHT**



**UPTO 65%
ENERGY SAVINGS***

Range of IoT enabled Fans available

*Energy conservation as compared with conventional non star rated fans

Connect  **within your home**

Connect from  **outside your home**



LOOK UP TO
ALBUS SMART SENSE
BLDC+FAN

+  **REVERSIBLE WOODEN BLADE**



All technology with Smart Sensing for Room Temperature and Humidity



Smart Sense for
auto speed adjustment



UPTO 65%*
ENERGY SAVINGS

Range of smartsense fans are available

*Energy conservation as compared with conventional non star rated fans

LOOK UP TO ENTICER PRIME BLDC+ FAN

+  &  **DUAL COMPATIBILITY
REMOTE & REGULATOR**



**UPTO 65%
ENERGY SAVINGS***

Range of Remote & Regulator compatible fans available

*Energy conservation as compared with conventional non star rated fans

INTRODUCTION TO

BLDC+

BLDC motor stands for Brushless Direct Current Motor. As the name suggests, it works on Direct Current of electricity instead of conventional induction motor, which uses Alternating Current.

BLDC motor uses permanent magnets, instead of electromagnets that are used in conventional motors. A permanent magnet generates a DC (Direct Current) magnetic field which interacts with the magnetic field of the Stator to generate motion. Since input electric supply from the power distribution source is AC, all BLDC fans are fitted with PCB which converts AC to DC. The permanent magnets of BLDC motor consume less Power with no Heat Loss, thus making these fans more energy efficient than regular fans with induction motor. This technology works smoothly even at low voltage and on power fluctuations.

BLDC motor was first made in 1962 however, In India, it started getting popularity, very recently. This technology reduces power consumption by up to 50%. Havells BLDC fans give power saving of upto 65%* when compared to conventional non-star rated fan. Ceiling fans with BLDC motors are energy-efficient and generate the same amount of airflow compared to Ordinary Fan.

Besides energy saving, Havells BLDC fans are equipped with high tech features like Voice control, IOT enabled, Automatic Speed Adjustment, Premium Aesthetics, High Air Delivery, Remote operation, Reverse Rotation, Low Noise, Light Weight, to name a few.

*Power saving calculation is based on fan running for 16 hours a day and electricity cost is considered as Rs. 7/- per unit.

BLDC+



Voice Command without Wi-Fi



Smart Sense Auto Speed adjustment



IoT & App Based Control



LED Light with Tunable & Dimming Technique

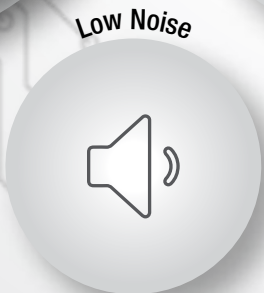

Low Noise



RF Remote for all direction sensing



100% Copper for better durability

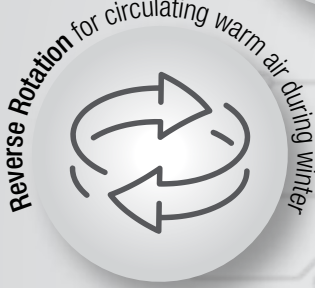

Reverse Rotation for circulating warm air during winter

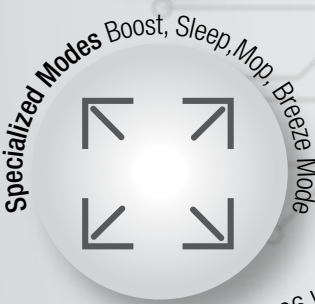

Specialized Modes Boost, Sleep, Mop, Breeze Mode

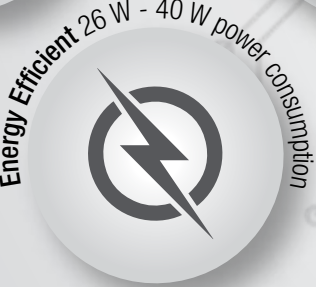

Energy Efficient 26 W - 40 W power consumption

10 REASONS TO BUY HAVELLS BLDC+ FANS

1

*Hello
Havells*

**INNOVATIVE AI
TECHNOLOGY**
VOICE ACTIVATED FAN
NO WIFI, NO INTERNET

2

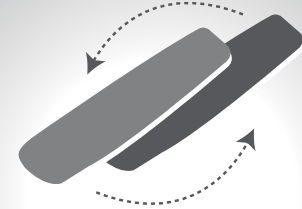

UNIQUE DUAL SIDE
USABLE WOODEN
BLADE FANS

6



100 % COPPER WIRE
COMMITMENT & ASSURANCE OF
HIGHEST QUALITY
TO CONSUMERS

7

HAVELLS

1st

ALL WEATHER FAN
WITH ROOM HEATER

3



INDIA'S LARGEST*
RANGE OF ARTIFICIALLY
INTELLIGENT FANS

4

Amaya
*A BEAUTIFUL
ITALIAN DESIGN*

**GERMAN DESIGN
AWARD WINNER 2024**
FOR EXCELLENT PRODUCT
DESIGN

5



INDIA'S LARGEST*
RANGE OF 5 STAR RATED
UNDERLIGHT FANS

8



**100 % FREE
INSTALLATION**
ON PREMIUM BLDC FANS

9



370
revolution per minute
Efficiencia
PRIME

INDIA'S FIRST*
BLDC HIGH SPEED FAN

10



26 WATT
EFFICIENCIA NEO

AWARDED AS
MOST ENERGY
EFFICIENT FAN 2021



HAVELLS



LOOK UP TO
BLDC +
UNDERLIGHT
FANS



HAVELLS



MOMENTA UNDERLIGHT (IoT)

Connect  from office

Connect  within your home

Connect from  outside your home



Underlight with Colour changing tech



Unique 4 blade design



RF remote control for all direction sensing



Low Noise



Free Installation



- Control your IOT enabled fan from office, home & outside home
- Mood Changing Underlight with Dimmable & Tunable technique
- All Direction Sensing RF Remote with Breeze, Sleep and Mop modes & Timer setting upto 8 hours
- Aerodynamic wood finish ABS blades for high air delivery

STAR RATING	SWEEP	POWER INPUT	SPEED	AIR DELIVERY
	1200 mm	40 W	280 r/min	245 m ³ /min



Smoke Brown Walnut



Smoke Brown Pinewood





ALBUS SMART SENSE UNDERLIGHT

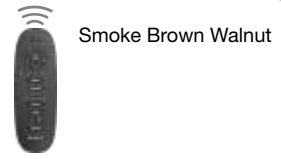

LED
Underlight with Colour changing tech

Unique 4 blade design

RF remote control for all direction sensing

Low Noise

Free Installation

Auto Humidity & Temperature Sensing

Reverse Rotation

Reversible Blade

100% COPPER WIRE WINDING MOTOR

- Side changeable reversible premium MDF wood blades to suit room decor
- Smart Sensing for Humidity and Temperature for Automatic Speed Adjustment
- Reverse Rotation for circulating warm air during winter
- Mood Changing Underlight with Dimmable & Tunable technique
- All Direction Sensing RF Remote with Breeze, Sleep and Mop modes along with Timer setting upto 8 hours



STAR RATING	SWEEP	POWER INPUT	SPEED	AIR DELIVERY
	1320 mm	40 W	270 r/min	245 m ³ /min





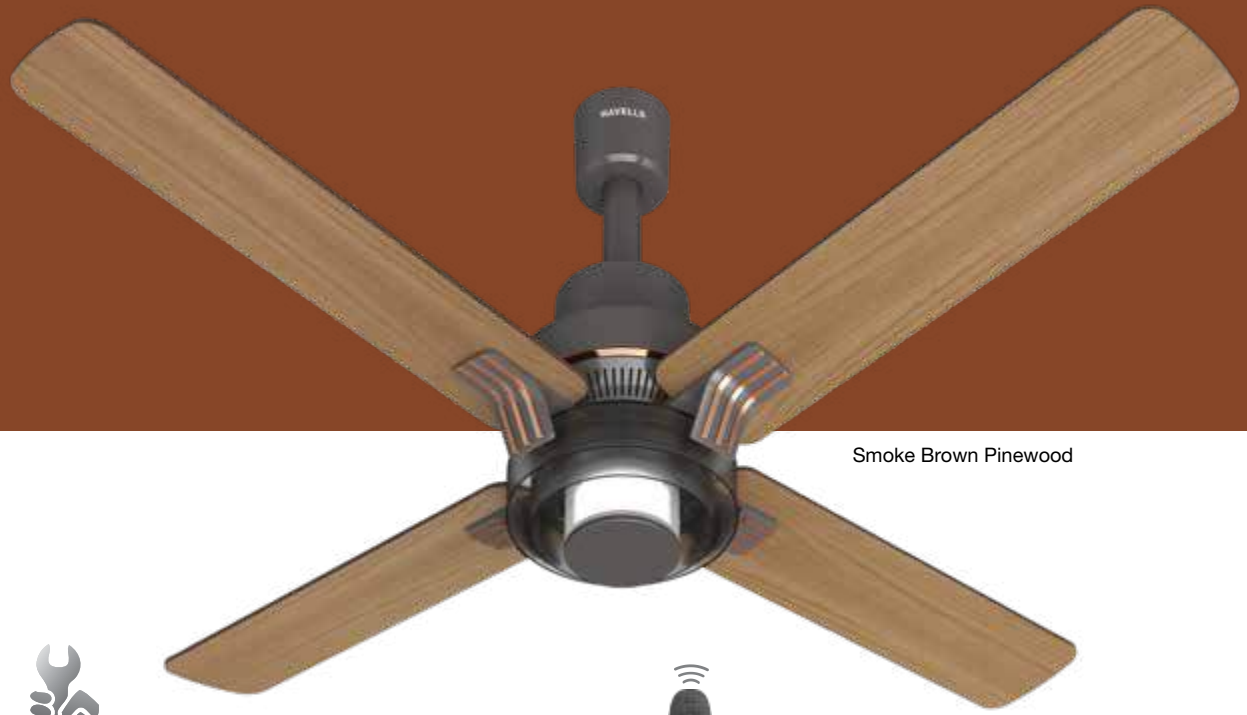

Smoke Brown Pinewood

FLORETTE SMART SENSE UNDERLIGHT



Underlight with Colour changing tech



Unique 4 blade design



RF remote control for all direction sensing



Low Noise



Free Installation



Auto Humidity & Temperature Sensing



Reverse Rotation

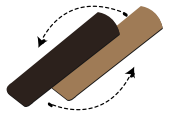

Reversible Blade



- Side changeable reversible premium MDF wood blades to suit room decor
- Smart Sensing for Humidity and Temperature for Automatic Speed Adjustment
- Reverse Rotation for spreading warm air during winter
- Mood Changing Underlight with Dimmable & Tunable technique
- All Direction Sensing RF Remote with Breeze, Sleep and Mop modes along with Timer setting upto 8 hours

STAR RATING	SWEEP	POWER INPUT	SPEED	AIR DELIVERY
	1320 mm	40 W	270 r/min	245 m ³ /min



Smoke Brown Walnut





INOX BLDC UNDERLIGHT (IoT)

Connect from office

Connect within your home

Connect from outside your home



Underlight with Colour changing tech



ABS feather finish blades



RF remote control for all direction sensing



Low Noise



Free Installation



Telescopic Canopy



Gold Mist Cola



Slate Chrome

- Control your IOT enabled fan from office, home & outside home
- Mood Changing Underlight with Dimmable & Tunable technique
- Telescopic canopy for adjusting to various ceiling heights
- All Direction Sensing RF Remote with Breeze and Sleep modes with Timer setting upto 8 hours

STAR RATING	SWEEP	POWER INPUT	SPEED	AIR DELIVERY
	1200 mm	40 W	280 r/min	245 m ³ /min



Pearl White Chrome



HAVELLS

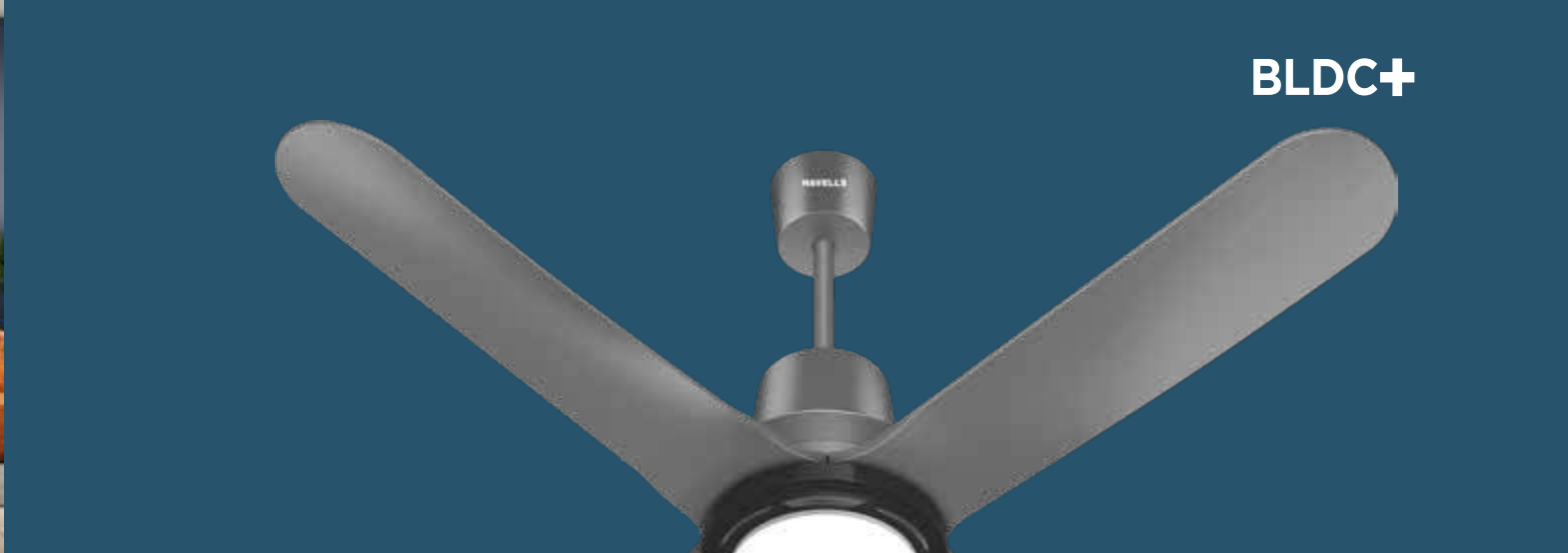

LIBECCIO BLDC UNDERLIGHT



Underlight with Colour changing tech



Aerodynamic ABS Blades



Unique 4 blade design



RF remote control for all direction sensing



Low Noise



Reverse Rotation



Free Installation



Slate

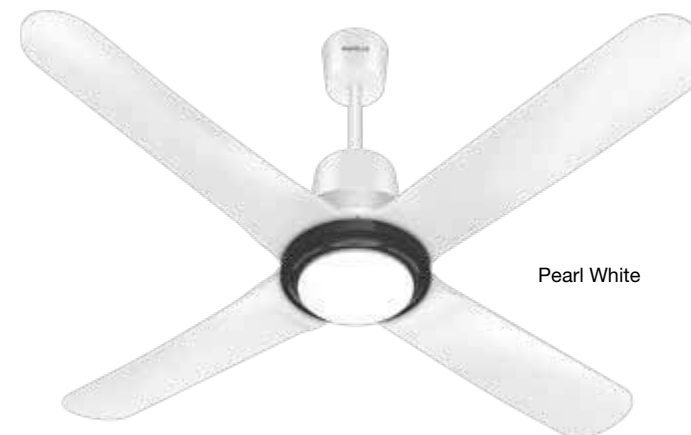

Pearl White

- Mood Changing Underlight with Dimmable & Tunable technique
- Aerodynamic ABS 4 blades for High Air delivery
- Reverse Rotation for circulating warm air during winter
- All Direction Sensing RF Remote with Breeze and Sleep modes with Timer setting upto 8 hours

STAR RATING	SWEEP	POWER INPUT	SPEED	AIR DELIVERY
	1200 mm	40 W	260 r/min	245 m ³ /min







ELIO PRIME

UNDERLIGHT (IoT)

Connect from office | Connect within your home | Connect from outside your home



Underlight with Colour changing tech

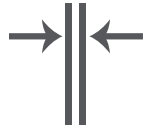

Sleek & Minimalistic Design

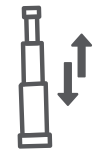

Telescopic Canopy



RF remote control for all direction sensing



Low Noise



Free Installation



Mist



Pine Wood Matt Black



Pearl White Champagne

- Control your IOT enabled fan from office, home & outside home
- Mood Changing Underlight with Dimmable & Tunable technique
- Telescopic canopy for adjusting to various ceiling heights
- All Direction Sensing RF Remote with Breeze, Sleep, Boost and Mop modes along with Timer setting upto 8 hours

STAR RATING	SWEEP	POWER INPUT	SPEED	AIR DELIVERY
	1200 mm	28 W	350 r/min	225 m ³ /min



NOTE : Dust Resistant coating is applicable on glossy finish only.





CERA BLDC UNDERLIGHT

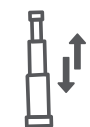

Telescopic Height



Reverse Rotation

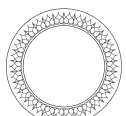

Special carving design



LED Halo Ambient Light



RF remote control for all direction sensing



- Unique transparent circular designer trims with halo lighting effect
- Balanced & smart design that provides easy cleaning
- Reverse Rotation for circulating warm air during winter
- All Direction Sensing RF Remote with Sleep, Breeze, Boost and Mop modes along with Timer setting upto 8 hours

STAR RATING	SWEEP	POWER INPUT	SPEED	AIR DELIVERY
	1200 mm	35 W	350 r/min	225 m ³ /min



Slate



Champagne



Pearl White



Mist





Champagne Cola

CRISTA BLDC UNDERLIGHT (IoT)

Connect from office

Connect within your home

Connect from outside your home



Underlight with Colour changing tech



Aerodynamic ABS blade with winglet design



RF remote control for all direction sensing



Low Noise



Free Installation



Telescopic Canopy



Pearl White LT Copper

- Control your IOT enabled fan from office, home & outside home
- Telescopic canopy for adjusting to various ceiling height
- Dual LED underlight for comfort and elegance
- All Direction Sensing RF Remote with Breeze and Sleep modes with Timer setting upto 8 hours

STAR RATING	SWEEP	POWER INPUT	SPEED	AIR DELIVERY
	1200 mm	40 W	300 r/min	255 m ³ /min



Slate Chrome





FLORETTE BLDC ALL WEATHER UNDERLIGHT

Use Your Fan in Winters too!
True All Weather Fan with Heater for extra warmth



Free Installation



Reverse Rotation



RF Remote control for all direction sensing



Low Noise

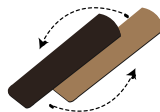

Reversible Blade



LED Ambient Underlight with colour changing technique



Integrated PTC heater with soothing Amber LED light



- In-built PTC heater with high energy efficiency and Zero Oxygen combustion to maintain freshness
- Reverse Rotation for circulating warm air during winter
- Side changeable reversible premium MDF wood blades to suit room decor
- Soft start mood Changing Ambient Underlight with Dimmable & Tunable technique
- All Direction Sensing RF Remote with Breeze, Mop and Sleep modes along with Timer setting upto 8 hours

STAR RATING	SWEEP	POWER INPUT	SPEED	AIR DELIVERY
	1320 mm	40 W	270 r/min	245 m ³ /min



NOTE : Power consumption of heater is 700 W



Smoke Brown Walnut



Smoke Brown Pinewood





STEALTH AIR BLDC

UNDERLIGHT

Free Installation

Reverse Rotation

RF Remote control for all direction sensing

Low Noise

LED Underlight with Colour changing tech

Aerodynamic ABS Blades

- LED Underlight with dimmable & tunable option
- Highest Air delivery in its class with 18 pole motor
- Dust & Mark Resistant ABS reinforced blades
- Reverse Rotation for circulating warm air during winter
- All Direction Sensing RF Remote with Sleep, Breeze, and Mop modes along with Timer setting upto 8 hours

STAR RATING	SWEEP	POWER INPUT	SPEED	AIR DELIVERY
	1200 mm	40 W	280 r/min	245 m ³ /min
	900 mm	26 W	400 r/min	145 m ³ /min



Metallic Black



Pearl White



Indigo Blue



Mist



Champagne



Slate



HAVELLS



LOOK UP TO

BLDC+
FANS





INVENO LX BLDC



Free Installation



Telescopic Canopy



Reverse rotation



Low Noise



RF remote control for all direction sensing



Aerodynamic ABS blade with seamless IMD trim



- IMD blade trims with glossy Star pattern on the blade
- Unique single body design with Premium Metallic Finish
- Aerodynamic blades for high air delivery
- Reverse Rotation for circulating warm air during winter
- All Direction Sensing RF Remote with Breeze, Sleep and Mop modes along with Timer setting upto 8 hours

STAR RATING	SWEEP	POWER INPUT	SPEED	AIR DELIVERY
	1200 mm	38 W	280 r/min	230 m ³ /min



Note : Also available model Inveno CQ BLDC in non metallic finish.
Dust resistant coating is applicable on glossy finish only.

Pearl Brown



Metallic Cream



Mist



Dusk



Slate



Pearl White



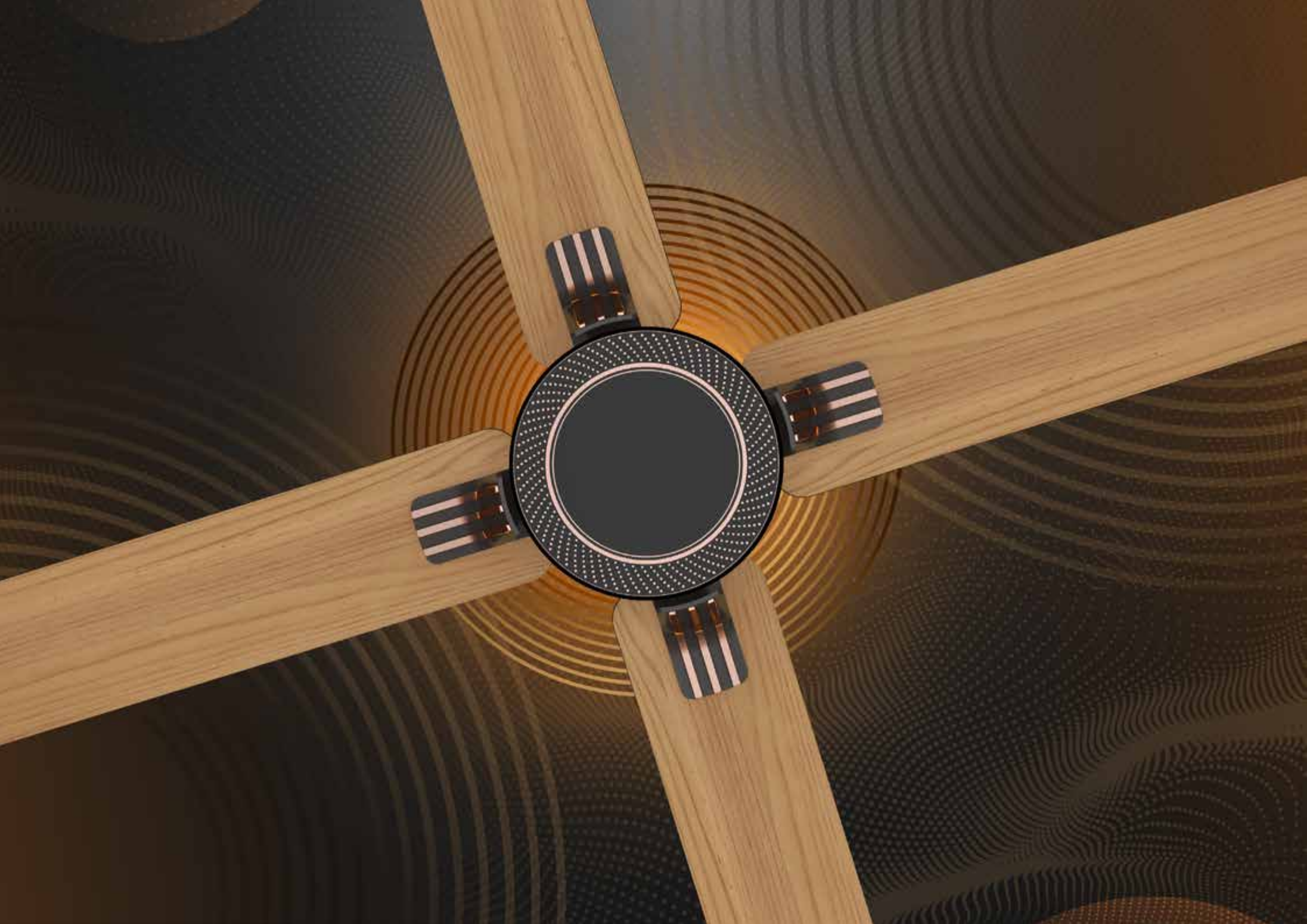



BLDC+

FLORETTE

BLDC



Unique 4 blade design



RF remote control for all direction sensing



Low Noise



Free Installation



Reverse rotation

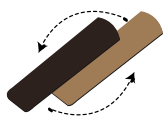

Reversible Blade



IMD deco pattern for premium looks

- Side changeable Premium MDF blades to suit your home decor
- Reverse Rotation for circulating warm air during winter
- All Direction Sensing RF Remote with Breeze, Sleep and Mop modes along with Timer setting upto 8 hours

STAR RATING	SWEEP	POWER INPUT	SPEED	AIR DELIVERY
	1320 mm	40 W	270 r/min	245 m³/min



Smoke Brown Walnut



Smoke Brown Pinewood





Hello Havells

STEALTH AIR

BLDC VOICE 2.0



Direct Voice Command



No Internet Required



RF remote control for all direction sensing



Low Noise



Free Installation



Reverse rotation



Aerodynamic ABS Blades



Indigo Blue



Pearl White



Metallic Black

- Direct Voice Controlled Fan with Innovative AI Technology.
- Talk To Your Fan Directly, does not require Internet ; Wifi ; Smart Phone or Bluetooth. It works on Wake up command by saying "Hello Havells" followed by Switch ON ; Switch OFF or One Speed, Two Speed & so on.. to control fans as per need.
- All Direction Sensing RF Remote with Breeze, Sleep and Mop modes along with Timer setting upto 8 hours
- Reverse Rotation for circulating warm air during winter

STAR RATING	SWEEP	POWER INPUT	SPEED	AIR DELIVERY
	1200 mm	40 W	280 r/min	245 m ³ /min





HAVELLS



STEALTH AIR

BLDC SMART (IoT)

Connect from office

Connect within your home

Connect from outside your home



Reverse Rotation



RF remote control for all direction sensing



Low Noise



Free Installation



Aerodynamic ABS Blades



- Control your IOT enabled fan from office, home & outside home
- Reverse Rotation for circulating warm air during winter
- All Direction Sensing RF Remote with Breeze, Sleep and Mop modes along with Timer setting upto 8 hours
- Aerodynamic ABS blades for high air delivery

STAR RATING	SWEEP	POWER INPUT	SPEED	AIR DELIVERY
	1200 mm	40 W	280 r/min	245 m ³ /min



Metallic Black



Pearl White



Indigo Blue



INOX BLDC

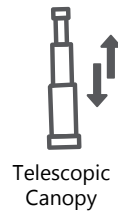

- Aerodynamic blades for Superior Air Delivery
- Dust Resistant coating on the blades
- Telescopic canopy for adjusting to various ceiling heights
- All Direction Sensing RF Remote with Breeze, Sleep and Mop modes along with Timer setting upto 8 hours
- Reverse Rotation for circulating warm air during winter

STAR RATING	SWEEP	POWER INPUT	SPEED	AIR DELIVERY
	1200 mm	38 W	280 r/min	245 m ³ /min

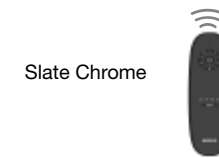



BLDC+



Slate Chrome

CRISTA BLDC



Aerodynamic blades with Winglet Design for low noise



RF remote control for all direction sensing



Low Noise



Free Installation



Telescopic Canopy



Reverse Rotation



- Aerodynamic Winglet blades for superior air delivery
- Telescopic canopy for adjusting to various ceiling heights
- All Direction Sensing RF Remote with Breeze, Sleep and Mop modes along with Timer setting upto 8 hours
- Reverse Rotation for circulating warm air during winter

STAR RATING	SWEEP	POWER INPUT	SPEED	AIR DELIVERY
	1200 mm	40 W	300 r/min	255 m ³ /min



Pearl White LT Copper



Champagne Cola

BLDC+



AMAYA BLDC

Silver Ash



Unique 4 blade Rivet-less design



RF remote control for all direction sensing



Low Noise



Free Installation



Reverse Rotation



- Italian Rivet-less design with Premium PU Finish
- Compound ABS blades for high strength, silent operation and better air delivery
- All Direction Sensing RF Remote with Breeze, Sleep and Mop modes along with Timer setting upto 8 hours
- Reverse Rotation for circulating warm air during winter



Satin White

STAR RATING	SWEEP	POWER INPUT	SPEED	AIR DELIVERY
	1400 mm	40 W	270 r/min	255 m³/min





BLDC+

LIBECCIO BLDC



Unique ABS
4 blade design



RF remote control for
all direction sensing



Low
Noise



Free
Installation



Reverse
Rotation

- Aerodynamic 4 blade for Superior Air Delivery
- Dust Resistant coating on ABS blades with premium metallic paint finish
- All Direction Sensing RF Remote with Breeze, Sleep and Mop modes along with Timer setting upto 8 hours
- Reverse Rotation for circulating warm air during winter



Slate



Pearl White

STAR RATING	SWEEP	POWER INPUT	SPEED	AIR DELIVERY
	1200 mm	40 W	260 r/min	245 m ³ /min



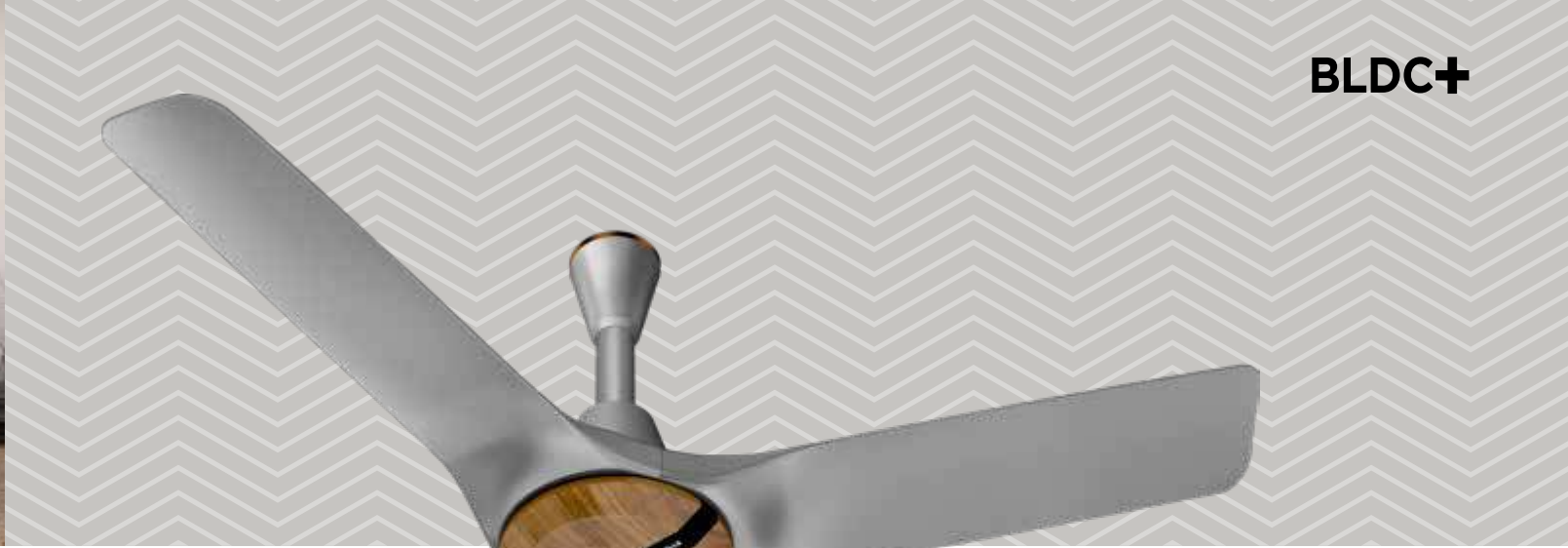

STEALTH NEO BLDC



Premium PU finish
ABS Blades



RF remote control for
all direction sensing



Low
Noise



Free
Installation



Reverse
Rotation



- Aerodynamic Blades for Superior Air delivery
- Dust Resistant ABS blades in premium PU finish
- All Direction Sensing RF Remote with Breeze, Sleep and Mop modes along with Timer setting upto 8 hours
- Reverse Rotation for circulating warm air during winter

STAR RATING	SWEEP	POWER INPUT	SPEED	AIR DELIVERY
	1200 mm	40 W	280 r/min	245 m ³ /min



NOTE : Dust Resistant coating is applicable on glossy finish only.



Mist
Wood

Mist Walnut

Pearl White Walnut

Pearl White Wood



STEALTH WOOD BLDC

Walnut Cola



Free Installation



Low Noise



RF remote control for all direction sensing



Reverse Rotation



Pinewood Cola

- Aerodynamic Blades for Superior Air Delivery
- All Direction Sensing RF Remote with Breeze, Sleep and Mop modes along with Timer setting upto 8 hours
- Reverse Rotation for circulating warm air during winter

STAR RATING	SWEEP	POWER INPUT	SPEED	AIR DELIVERY
	1200 mm	40 W	280 r/min	245 m³/min





STEALTH AIR BLDC



Premium PU finish
ABS Blades



RF remote control for
all direction sensing



Low
Noise



Free
Installation



Reverse
Rotation



- Aerodynamic Blades for Superior Air delivery
- Dust Resistant coating on ABS blades with premium metallic paint finish
- All Direction Sensing RF Remote with Breeze, Sleep and Mop modes along with Timer setting upto 8 hours
- Reverse Rotation for circulating warm air during winter

STAR RATING	SWEEP	POWER INPUT	SPEED	AIR DELIVERY
	1200 mm	40 W	280 r/min	245 m ³ /min



Indigo Blue



Pearl White



Metallic Black



Mist



Champagne



Slate



BLDC+

STEALTH PRIME BLDC



Premium PU finish
ABS Blades



RF remote control for
all direction sensing



Low
Noise



Free
Installation



Dust
Resistant
Lacquering
Easy Cleaning of Blades



100%
COPPER WIRE
WINDING MOTOR



Reverse
Rotation

- Aerodynamic Blades for Superior Air delivery
- Dust Resistant coating on ABS blades with premium metallic paint finish
- All Direction Sensing RF Remote with Breeze, Sleep and Mop modes along with Timer setting upto 8 hours
- Reverse Rotation for circulating warm air during winter

STAR RATING	SWEEP	POWER INPUT	SPEED	AIR DELIVERY
	1200 mm	40 W	280 r/min	245 m ³ /min



Marble Pearl White



Marble Dusk



ELIO PRIME



Sleek & Minimalistic Design



RF remote control for all direction sensing



Low Noise



Telescopic Canopy



Reverse Rotation

- Telescopic canopy for adjusting to various ceiling heights
- Premium Metallic & Wooden Finish
- All Direction Sensing RF Remote with Breeze, Sleep, Boost and Mop modes along with Timer setting upto 8 hours
- Reverse Rotation for circulating warm air during winter

STAR RATING	SWEEP	POWER INPUT	SPEED	AIR DELIVERY
	1200 mm	28 W	350 r/min	225 m ³ /min



Prime Matt Black



Walnut



Slate Mist



Pine Wood Pearl White



Mist Pearl White



Pine Wood Matt Black

NOTE : Dust Resistant coating is applicable on glossy finish only



BLDC+



ELIO



Sleek & Minimalistic Design



RF remote control for all direction sensing



Low Noise



Telescopic Canopy



Reverse Rotation

- Sleek & Minimalistic Design to enhance room decor
- Telescopic canopy for adjusting to various ceiling heights
- All Direction Sensing RF Remote with Breeze, Sleep, Boost and Mop modes along with Timer setting upto 8 hours
- Reverse Rotation for circulating warm air during winter

STAR RATING	SWEEP	POWER INPUT	SPEED	AIR DELIVERY
	900 mm	28 W	160 r/min	430 m ³ /min
	1200 mm	28 W	350 r/min	225 m ³ /min
	1400 mm	35 W	250 r/min	300 m ³ /min



Grey



Matt Black



Brown



Bianco



Smoke Brown

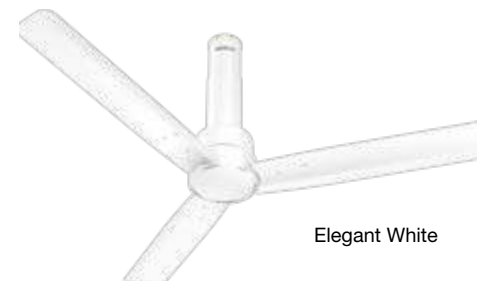

Elegant White



ELIO PLUS R & R



Telescopic Height



Reverse Rotation



Low Noise



Sleek & Minimalistic Design



Dust Resistant Lacquering of Blades
Easy Cleaning of Blades



RF remote control for all direction sensing



REMOTE & REGULATOR COMPATIBLE



100% COPPER WIRE WINDING MOTOR
BETTER QUALITY

- Ease of operations: Works on both Remote & Regulator
- Sleek & Minimalistic Design to enhance room decor
- Telescopic canopy for adjusting to various ceiling heights
- Reverse Rotation for circulating warm air during winter
- All Direction Sensing RF Remote with Breeze, Sleep, Boost and Mop modes along with Timer setting upto 8 hours

STAR RATING	SWEEP	POWER INPUT	SPEED	AIR DELIVERY
	1200 mm	28 W	350 r/min	225 m ³ /min



NOTE : Dust Resistant coating is applicable on glossy finish only





BLDC+



ELIO PRIME

SMART (IoT)

Connect  from office

Connect  within your home

Connect from  outside your home



Sleek & Minimalistic Design



RF remote control for all direction sensing



Low Noise



Reverse Rotation



Telescopic Canopy



- Control your IOT enabled fan from office, home & outside home
- Reverse Rotation for circulating warm air during winter
- Telescopic canopy for adjusting to various ceiling heights
- Premium Wooden Finish
- All Direction Sensing RF Remote with Breeze, Sleep, Boost and Mop modes along with Timer setting upto 8 hours

STAR RATING	SWEEP	POWER INPUT	SPEED	AIR DELIVERY
	1200 mm	28 W	350 r/min	225 m ³ /min



Slate Mist



Pine Wood Matt Black



Mist Pearl White

NOTE : Dust Resistant coating is applicable on glossy finish only



Espresso Brown LT Copper

ENTICER PRIME BLDC (R+R)



RF remote control for all direction sensing



Low Noise



Reverse Rotation



- Ease of operations: Works on both Remote & Regulator
- All Direction Sensing RF Remote with Breeze, Sleep and Mop modes along with Timer setting upto 8 hours
- Contemporary design with wide blades for high air delivery
- Reverse Rotation for circulating warm air during winter

STAR RATING	SWEEP	POWER INPUT	SPEED	AIR DELIVERY
	1200 mm	35 W	370 r/min	235 m ³ /min
	1400 mm	35 W	300 r/min	250 m ³ /min

NOTE : Dust Resistant coating is applicable on glossy finish only



Champagne

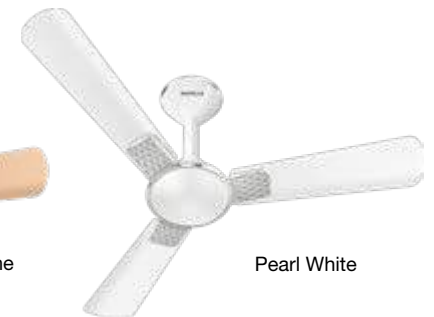

Pearl White



Pearl White Chrome



Indigo Blue Chrome



Bronze Copper Cola Chrome





EPIC SIGNIA BLDC



Reverse Rotation



Low Noise



Sleek & Minimalistic Design



LED Display for Speed & Modes indication



RF remote control for all direction sensing



- Unique LED display to indicate speed & mode
- Reverse Rotation for circulating warm air during winter
- Sleek design with Body Ring for premium aesthetics
- All Direction Sensing RF Remote with Sleep, Breeze, Mop and Boost modes along with Timer setting upto 8 hours

STAR RATING	SWEEP	POWER INPUT	SPEED	AIR DELIVERY
	1200 mm	30 W	350 r/min	225 m ³ /min



Cocoa Brown



Stone Grey



Blush Ivory



Denim Blue



Matt Black



Elegant White



Smoke Brown





EPIC PRO BLDC



Reverse Rotation



Low Noise



Sleek & Minimalistic Design



RF remote control for all direction sensing



- Sleek & Minimalistic Design with body ring to enhance room decor
- Reverse Rotation for circulating warm air during winter
- All Direction Sensing RF Remote with Sleep, Breeze, Mop and Boost modes along with Timer setting upto 8 hours

STAR RATING	SWEEP	POWER INPUT	SPEED	AIR DELIVERY
	1200 mm	30 W	350 r/min	225 m ³ /min



Smoke Brown



Bianco



Matt Black



Elegant White



Blush Ivory



Cocoa Brown



Denim Blue



Grey



Stone Grey



EPIC BLDC



Sleek & Minimalistic Design



RF remote control for all direction sensing



Low Noise



Reverse Rotation



- Sleek & Minimalistic Design to enhance room decor
- Reverse Rotation for circulating warm air during winter
- All Direction Sensing RF Remote with Boost, Breeze, Sleep and Mop modes along with Timer setting upto 8 hours

STAR RATING	SWEEP	POWER INPUT	SPEED	AIR DELIVERY
	1200 mm	30 W	350 r/min	225 m ³ /min





EFFICIENCIA NEO+



26
Watt



RF remote control for
all direction sensing



Low
Noise



Reverse
Rotation



- Ribbed Blades for High Strength
- Reverse Rotation for circulating warm air during winter
- All Direction Sensing RF Remote with Boost, Breeze, Sleep and Mop modes along with Timer setting upto 8 hours

STAR RATING	SWEEP	POWER INPUT	SPEED	AIR DELIVERY
	1400 mm	38 W	300 r/min	245 m ³ /min
	1200 mm	26 W	350 r/min	220 m ³ /min
	900 mm	28 W	460 r/min	150 m ³ /min



White

Bianco

Brown

NOTE : Also available without remote in regulator compatible variant for projects and institutions



EFFICIENCIA DX



26
Watt



RF remote control for
all direction sensing



Low
Noise



Reverse
Rotation



- Ribbed Blades for High Strength
- Reverse Rotation for circulating warm air during winter
- All Direction Sensing RF Remote with Boost, Breeze, Sleep and Mop modes along with Timer setting upto 8 hours

STAR RATING	SWEEP	POWER INPUT	SPEED	AIR DELIVERY
	1400 mm	34 W	290 r/min	260 m ³ /min
	1200 mm	30 W	350 r/min	225 m ³ /min
	900 mm	26 W	420 r/min	145 m ³ /min



Brown



Bianco



White

NOTE : Also available without remote in regulator compatible variant for projects and institutions

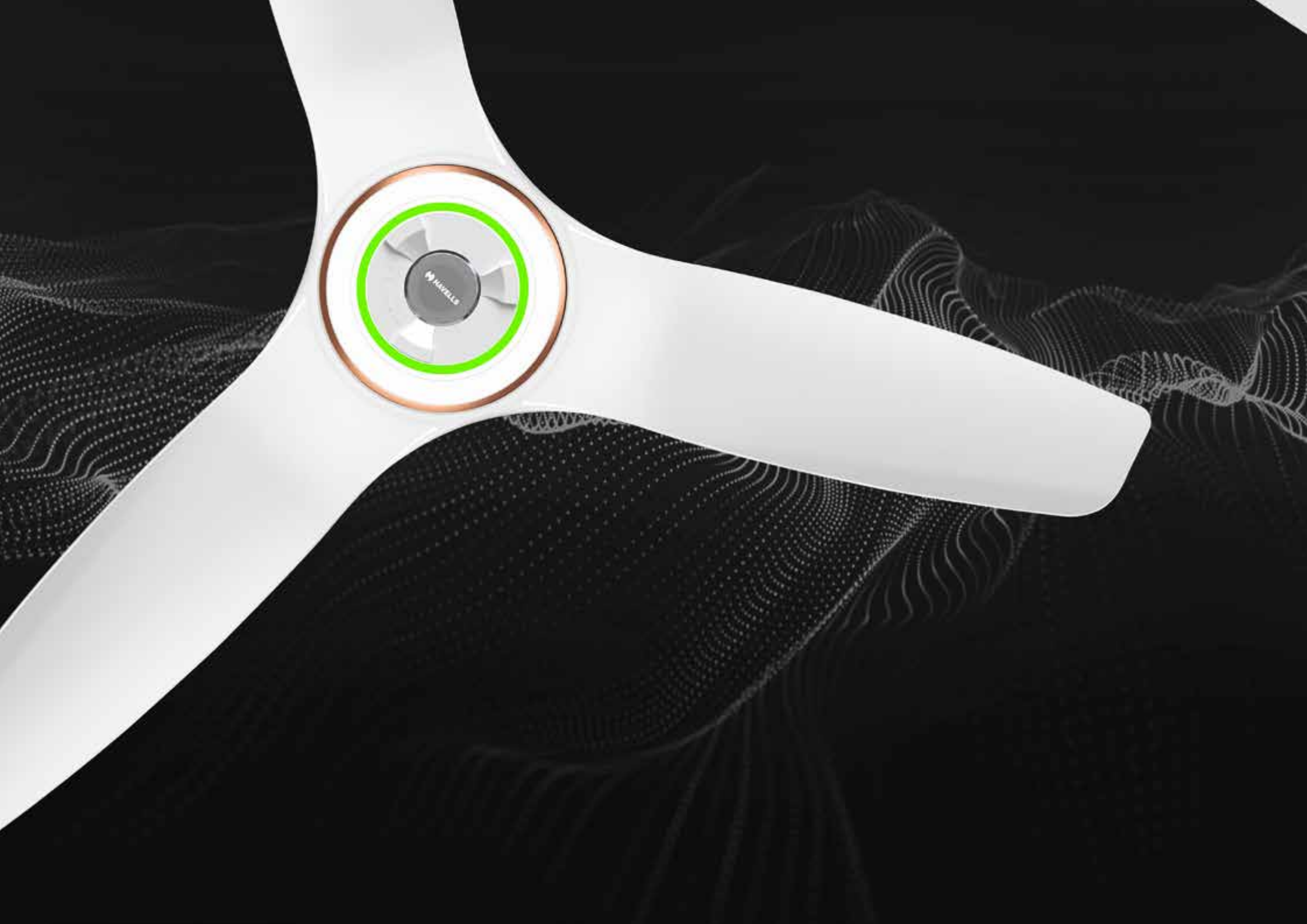



LOOK UP TO
UNDERLIGHT
ENERGY
SAVING FANS





STEALTH ES

PURO AIR



Height Adjustable Canopy



Upper Ceiling Mood Light & LED Underlight



H-II HEPA & Carbon Filter



Free Installation



Low Noise



Aerodynamic ABS Blades



- Elegant Design with Premium Trims & ABS molded blades
- Built-in Air Purifier with independent & synchronous operation modes with fan
- Upper Ceiling Mood-light and LED underlight
- LED Indicator for real time air quality index display

STAR RATING	SWEEP	POWER INPUT	SPEED	AIR DELIVERY
	1200 mm	60 W	270 r/min	245 m ³ /min



Pearl White Lt Copper



GOOD AQI



MODERATE AQI



UNHEALTHY AQI



VERY UNHEALTHY AQI



HAZARDOUS AQI



HAVELLS



OCTET ES

UNDERLIGHT



Low Noise



RF remote control for all direction sensing



Underlight with Colour changing tech



Free Installation

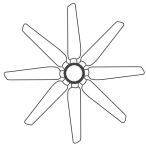

8 Wooden Finish blades



- Contemporary Look with 8 blades
- Superior Air Delivery with Low Noise
- Mood Changing Underlight with Dimmable & Tunable Technique
- All Direction sensing RF Remote with Breeze and Sleep mode along with Timer setting upto 8 hours

STAR RATING	SWEEP	POWER INPUT	SPEED	AIR DELIVERY
	1320 mm	62 W	280 r/min	260 m ³ /min



Brushed Nickel Wenge



Black Nickel Walnut



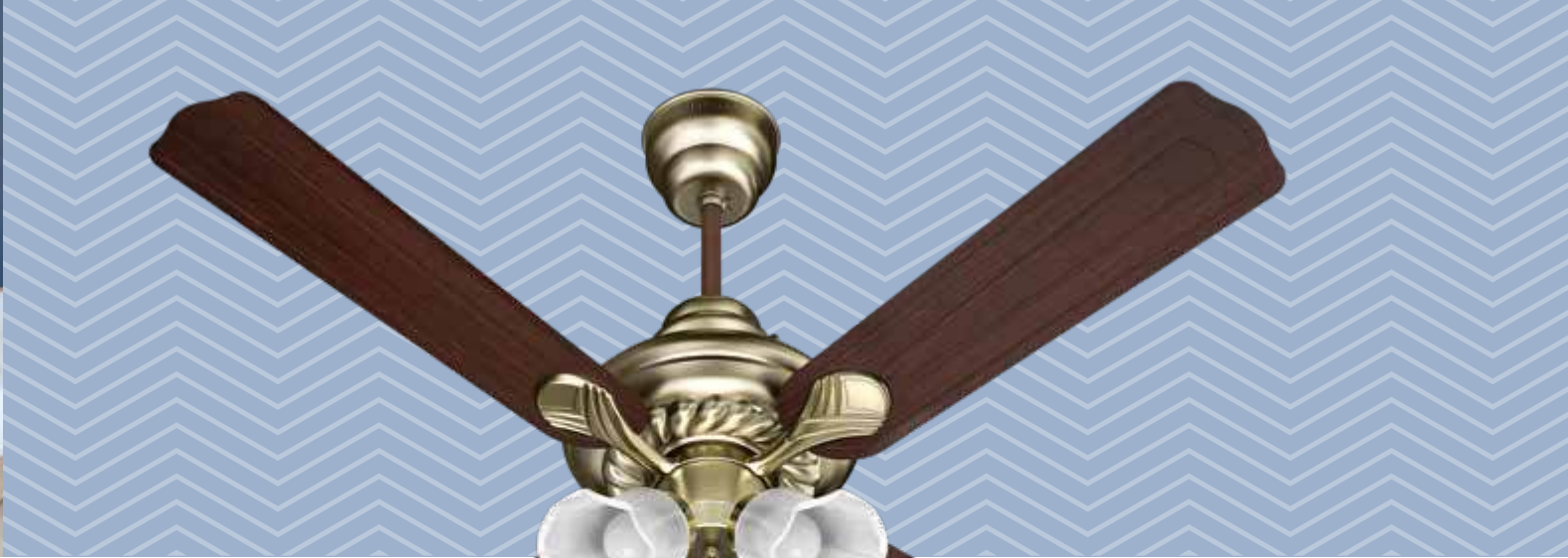

FLORENCE ES

UNDERLIGHT



Unique 4 blade design

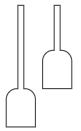

Pull cord for Speed & Light function



Underlight



Free Installation



- Premium Antique Looks with 4 lamp designs
- Reverse rotation switch for circulating warm air during winter
- Contemporary wood finish to match home decor

STAR RATING	SWEEP	POWER INPUT	SPEED	AIR DELIVERY
	1200 mm	53 W	310 r/min	218 m ³ /min



Wenge Black Antique Brass



Walnut Black Antique Copper



Elegant White Nickel



HAVELLS



TRINITY ES

UNDERLIGHT

Pearl White Chrome

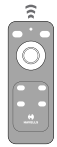

IR remote control for all direction sensing



Underlight with Colour changing tech



Free Installation

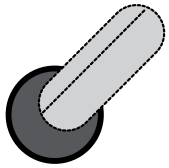

Non-rivet Blade design



- Mood Changing LED Underlight with Dimming Features
- Futuristic Shank-less design with Metallic paint finish
- IR Remote control for Fan, Light, Intensity control
- Superior metallic paint finish with invisible shanks for modern look
- Breeze & Sleep mode control through remote



Pearl White Lt Copper



Metallic Black Lt Copper

STAR RATING	SWEEP	POWER INPUT	SPEED	AIR DELIVERY
	1200 mm	53 W	320 r/min	220 m ³ /min





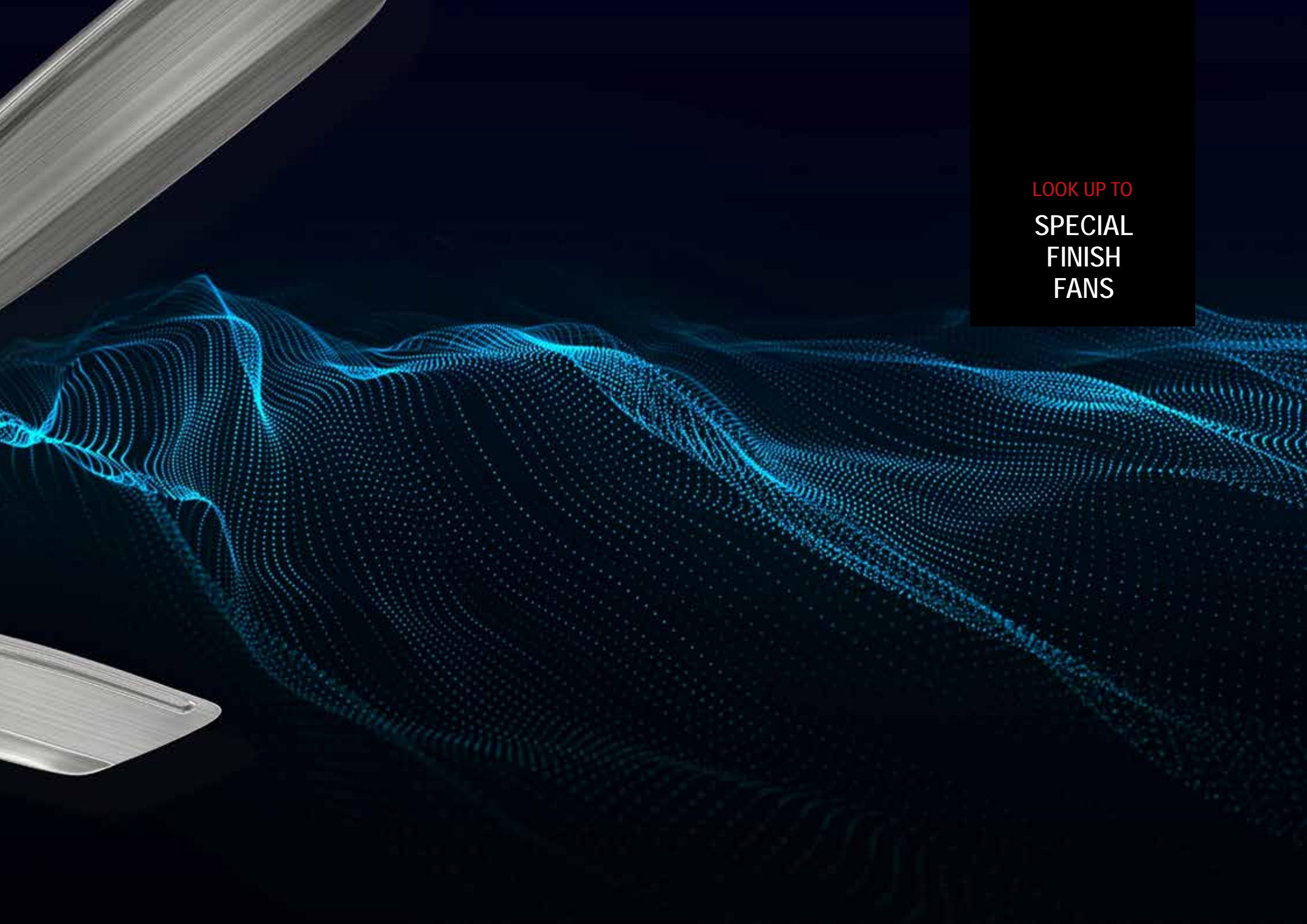

LOOK UP TO
SPECIAL
FINISH
FANS



OCTET ES



Walnut Black Nickel

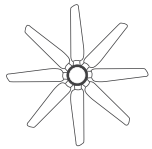

8 Wooden Finish blades



Free Installation



Low Noise



RF remote control for all direction sensing



- Unique 8 blades with robust motor
- Contemporary Looks with state-of-the-art aesthetics & styling
- Superior air delivery with low noise

STAR RATING	SWEEP	POWER INPUT	SPEED	AIR DELIVERY
	1320 mm	62 W	280 r/min	260 m ³ /min



Wenge Brushed Nickel



FLORENCE ES



Black Antique Copper



Unique 4 blade design



Free Installation



PREMIUM METALLIC FINISH



100% COPPER WIRE WINDING MOTOR

- Reverse rotation switch for circulating warm air during winter
- Premium Antique Looks in 1 star rating
- Contemporary finish to match home decor



Nickel Gold



Black Antique Brass

STAR RATING	SWEEP	POWER INPUT	SPEED	AIR DELIVERY
	1200 mm	53 W	310 r/min	218 m ³ /min





STEALTH AIR I - ES

WOOD (IoT)

Connect  from office

Connect  within your home

Connect from  outside your home

Pinewood Cola



Smart Sense



Free Installation



Rust Proof ABS Blades



Walnut Cola



- Smart Sense mode for Humidity & Temperature for automatic Speed Control
- Control your IOT enabled fan from office, home & outside home
- High Air delivery with 18 pole motor
- All direction sensing RF remote with Sleep & Breeze mode along with Timer setting up to 8 hours

STAR RATING	SWEEP	POWER INPUT	SPEED	AIR DELIVERY
	1200 mm	60W	270 r/min	245 m ³ /min





STEALTH AIR ES

WOOD

Walnut Cola



Free Installation



Rust Proof ABS Blades



Low Noise



- Aerodynamic ABS blades for superior air delivery
- Strong 18 pole motor



Pinewood Cola

STAR RATING	SWEEP	POWER INPUT	SPEED	AIR DELIVERY
	1200 mm	62 W	270 r/min	245 m ³ /min





STEALTH AIR ES



Free Installation





Rust Proof ABS Blades



Low Noise



- Aerodynamic Blades for Superior Air delivery
- Dust Resistant coating on ABS blades with premium paint finish

STAR RATING	SWEEP	POWER INPUT	SPEED	AIR DELIVERY
	1200 mm	60 W	270 r/min	245 m ³ /min
	900 mm	45 W	400 r/min	145 m ³ /min



Indigo Blue



Pearl White



Metallic Black



TRINITY I - ES (IoT)

Connect from office

Connect within your home

Connect from outside your home

Dusk LT Copper



Free Installation



RF remote control for all direction sensing



Smart Sense

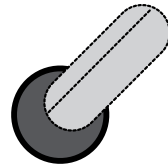

Non-rivet Blade design



- Informative 7 segment display for fan speed & room temperature
- Futuristic Shank-less design with metallic paint finish
- Remote control for Speed & Timer setting upto 8 hours
- Smart sense mode for temperature & humidity sensing



Silver Chrome



Metallic Cream Nickel

STAR RATING	SWEEP	POWER INPUT	SPEED	AIR DELIVERY
	1200 mm	53 W	320 r/min	220 m ³ /min





TRINITY ES



Metallic Black LT Copper

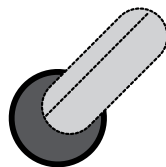

Non-rivet Blade design

- Futuristic Shank-less design with metallic paint finish
- Modular motor for superior performance

STAR RATING	SWEEP	POWER INPUT	SPEED	AIR DELIVERY
	1200 mm	53 W	220 r/min	320 m ³ /min



Dusk LT Copper



Pearl White Chrome





YORKER ES

Brushed Nickel



Unique 4 blade design



Free Installation



Antique Brass



Antique Copper

- Electroplated finish for premium & exotic looks
- Four blade for wider Air Delivery

STAR RATING	SWEEP	POWER INPUT	SPEED	AIR DELIVERY
	1200 mm	62 W	280 r/min	260 m ³ /min





ORION ES

Antique Brass





- Exotic Rich looks with Lacquered Anti-rust Surface
- Wider Blades for Better Air Circulation
- Electroplated finish to suit room decor



Antique Copper



Brushed Nickel

STAR RATING	SWEEP	POWER INPUT	SPEED	AIR DELIVERY
	1200 mm	52 W	350 r/min	215 m ³ /min
	900 mm	42 W	420 r/min	140 m ³ /min







EP TRENDY ES



Antique Brass



- Electroplated finish for premium & exotic looks
- Wider tip blades for effective Air circulation

STAR RATING	SWEEP	POWER INPUT	SPEED	AIR DELIVERY
	1200 mm	52 W	350 r/min	220 m ³ /min
	900 mm	42 W	420 r/min	140 m ³ /min
	600 mm	60 W	800 r/min	100 m ³ /min

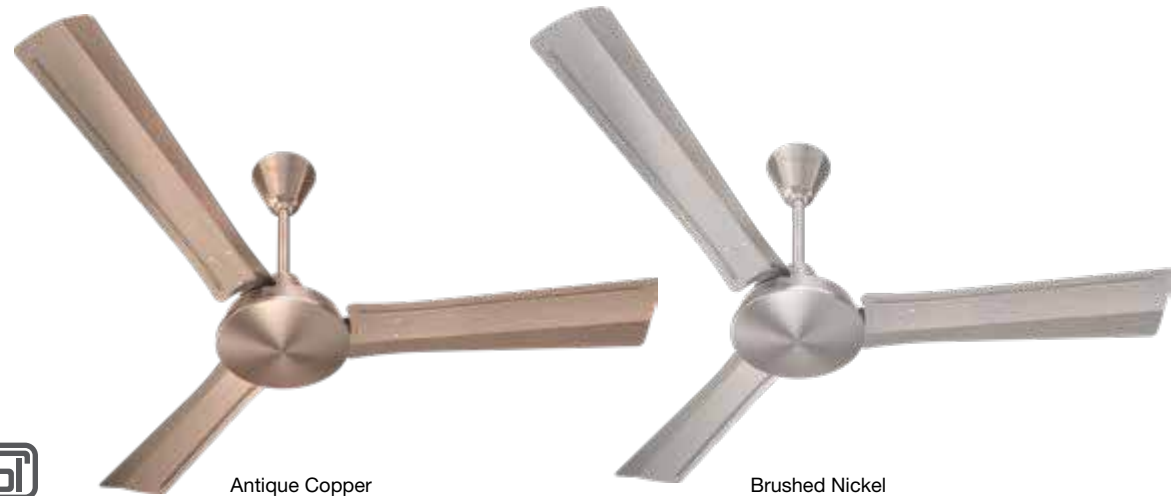

Antique Copper

Brushed Nickel



STEALTH NEO ES



Rust Proof ABS
Blades



Free Installation



- Aerodynamic Blades for Superior Air delivery
- Dust Resistant ABS blades in premium PU finish

STAR RATING	SWEEP	POWER INPUT	SPEED	AIR DELIVERY
	1200 mm	60 W	270 r/min	245 m ³ /min



Pearl White
Wood



Mist
Walnut



Pearl White
Walnut



Mist
Wood

Note: Dust resistant coating is applicable on glossy finish only.



STEALTH PRIME ES

Marble Dusk



Rust Proof ABS Blades



Free Installation



- Aerodynamic Blades for Superior Air delivery
- Dust Resistant ABS blades in premium PU finish

STAR RATING	SWEEP	POWER INPUT	SPEED	AIR DELIVERY
	1200 mm	60 W	270 r/min	245 m ³ /min



Note: Dust resistant coating is applicable on glossy finish only.



Marble Pearl White





LOOK UP TO
**KIDS
RANGE**



SAUROUS WORLD ES

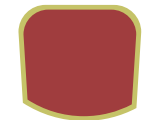

Wider Blade Tip



Exclusive Design
for Kids room

- Exclusive Kids Design with static center
- Wider Tip blade for more air Spread

STAR RATING	SWEEP	POWER INPUT	SPEED	AIR DELIVERY
	1200 mm	55 W	350 r/min	226 m ³ /min





OCEAN QUEST ES



Wider Blade Tip



Exclusive Design
for Kids room

- Exclusive Kids Design with static center
- Wider Tip blade for more air Spread

STAR RATING	SWEEP	POWER INPUT	SPEED	AIR DELIVERY
	1200 mm	55 W	350 r/min	226 m ³ /min





UNICORN ES



Wider Blade Tip



Exclusive Design
for Kids room

- Exclusive Kids Design with static center
- Wider Tip blade for more air Spread

STAR RATING	SWEEP	POWER INPUT	SPEED	AIR DELIVERY
	1200 mm	55 W	350 r/min	226 m ³ /min







LOOK UP TO
DECORATIVE
CEILING
FANS





EVA

Matt Espresso Linings



Low Noise



Downrod cover



High Air Delivery

- Dual tone rainbow sparkle finish
- IMD blade trims & bottom showcap to give you natural material feel of Marble, Brass & Indian Craft Wicker
- Sleek and smartly designed blade trim for elegance & easy cleaning
- Wide blades for high air delivery
- Premium canopy set with Downrod Cover for enhanced looks



Nature Inspired Trim & Bottom Show Cap



Pearl White Marble



Metallic Cream Wicker

STAR RATING	SWEEP	POWER INPUT	SPEED	AIR DELIVERY
	1200 mm	57 W	370 r/min	228 m ³ /min





IONIQ



High Air Delivery



Low Noise



Telescopic Canopy



- Rainbow Pearl Finish Blade Trims & Bottom Show cap with metallic accents
- Sleek and smartly designed blade trims for elegance & easy cleaning
- Telescopic canopy to suit various ceiling heights
- Modern design with body ring to elevate aesthetic value
- Wide blades for high air delivery

STAR RATING	SWEEP	POWER INPUT	SPEED	AIR DELIVERY
	1200 mm	55 W	350 r/min	220 m ³ /min



Rainbow Brown



Rainbow White

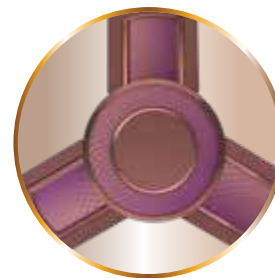

Rainbow Finish Trim & Bottom Show Cap



Rainbow Cream



Metallic Black

ENTICER ART ES

LIMITED EDITION



- Unique IMD Pattern to complement interior decor
- Wider Blade tip with Superior Metallic Paint Finish
- Rich looks with modern styling

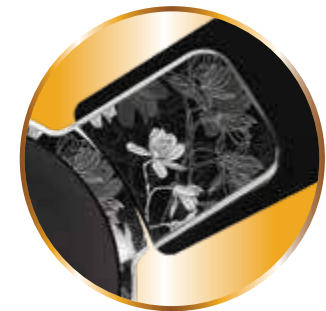

STAR RATING	SWEEP	POWER INPUT	SPEED	AIR DELIVERY
	1400 mm	60 W	290 r/min	250 m ³ /min
	1200 mm	57 W	380 r/min	230 m ³ /min
	900 mm	42 W	420 r/min	140 m ³ /min



Pearl White

Note: Dust resistant coating is applicable on glossy finish only.





ENTICER ART ES

HERITAGE EDITION

Espresso Brown Copper

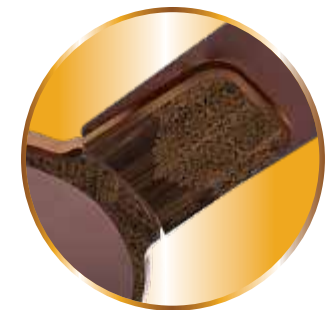

- Unique IMD Pattern to complement interior decor
- Wider Blade tip with Superior Metallic Paint Finish
- Rich looks with modern styling

STAR RATING	SWEEP	POWER INPUT	SPEED	AIR DELIVERY
	1200 mm	57 W	380 r/min	230 m ³ /min



Note: Dust resistant coating is applicable on glossy finish only.



ENTICER ES

WOOD

Oakwood



- Unique IMD Pattern to complement interior decor
- Wider Blade tip with Superior Metallic Paint Finish
- Rich looks with modern styling

STAR RATING	SWEEP	POWER INPUT	SPEED	AIR DELIVERY
	1200 mm	57 W	380 r/min	230 m ³ /min



Note: Dust resistant coating is applicable on glossy finish only.



Rosewood



Walnut

ENTICER ART ES

VINEER EDITION



- Unique IMD Pattern to complement interior decor
- Wider Blade tip with unique wood finish
- Rich looks with modern styling
- Special dust resistant paint finish

STAR RATING	SWEEP	POWER INPUT	SPEED	AIR DELIVERY
	1200 mm	57 W	380 r/min	230 m ³ /min



Note: Dust resistant coating is applicable on glossy finish only.



ENTICER ART ES

NATURE SERIES



- Unique IMD Pattern to complement interior decor
- Wider Blade tip with Superior Metallic Paint Finish
- Rich looks with modern styling

STAR RATING	SWEEP	POWER INPUT	SPEED	AIR DELIVERY
	1200 mm	57 W	380 r/min	230 m ³ /min



Espresso Brown



Beige



Stone Pearl White

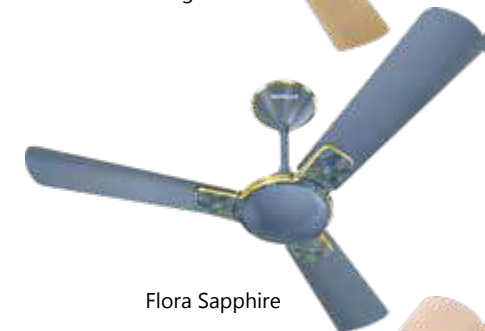

Flora Sapphire



Wave Pearl Brown

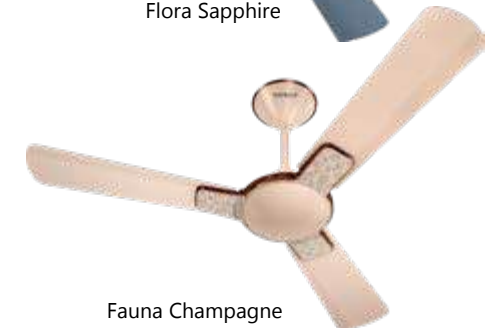

Fauna Champagne

Note: Dust resistant coating is applicable on glossy finish only.



ENTICER ART ES

COLLECTOR EDITION

Rose Gold



- Unique IMD Pattern to complement interior decor
- Wider Blade tip with Superior Metallic Paint Finish
- Rich looks with modern styling

STAR RATING	SWEEP	POWER INPUT	SPEED	AIR DELIVERY
	1200 mm	57 W	380 r/min	230 m ³ /min



Note: Dust resistant coating is applicable on glossy finish only.





ENTICER ES



- High performance motor with optimum air delivery
- Wider Blade tip with Superior Metallic Paint Finish

STAR RATING	SWEEP	POWER INPUT	SPEED	AIR DELIVERY
	1400 mm	60 W	290 r/min	250 m ³ /min
	1200 mm	57 W	380 r/min	230 m ³ /min
	900 mm	42 W	420 r/min	140 m ³ /min
	600 mm	60 W	800 r/min	100 m ³ /min

Note: Dust resistant coating is applicable on glossy finish only.

Pearl Ivory Beige



Maroon Chrome



Beige Copper



Pearl White Gold



Rose Gold



Pearl White Chrome



Metallic Black Chrome



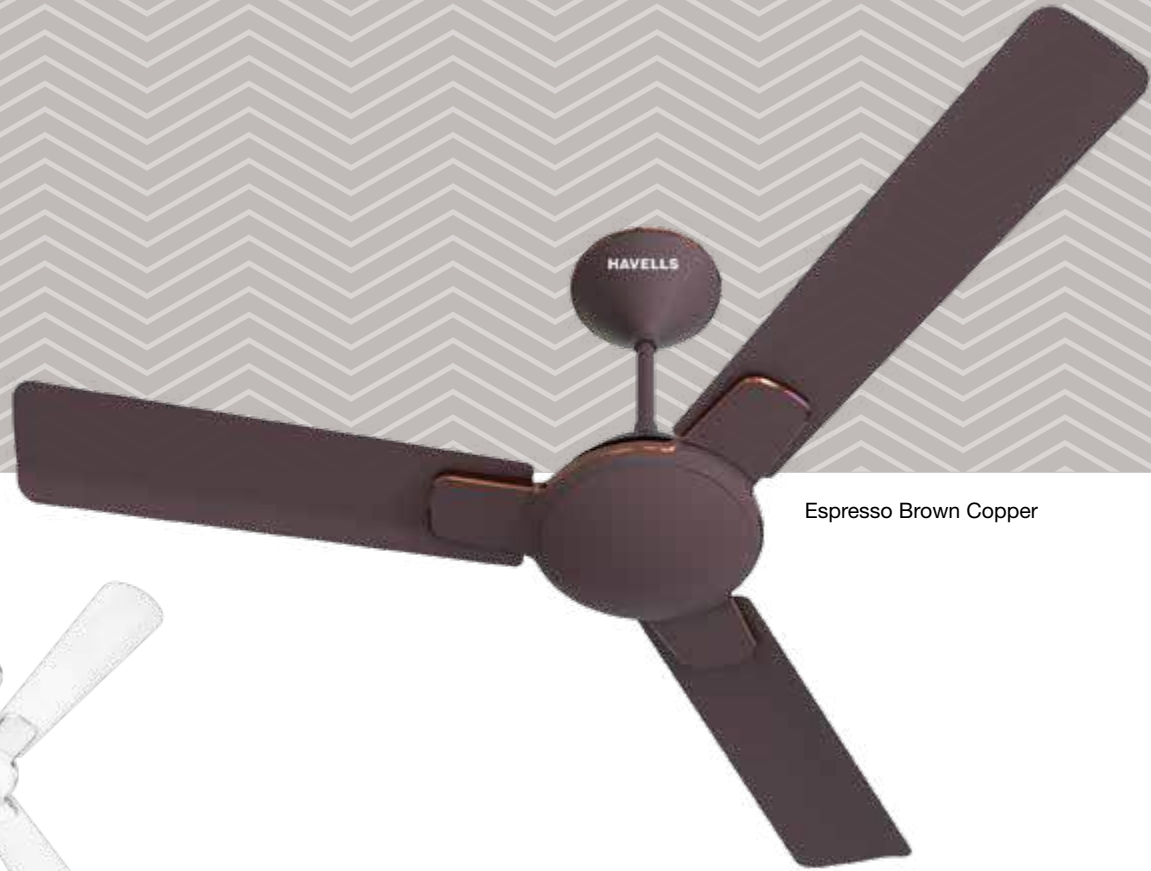

Espresso Brown Copper



Bronze Cola Chrome



Matt White Chrome



Pearl Ivory Cola Chrome



Sapphire Silver



Pearl White Rose Gold



Indigo Blue Chrome



Bronze Pearl Brown

Note: Dust resistant coating is applicable on glossy finish only.



ZESTER ES



Tangential Blade



Wider Blade Tip



HIGH SPEED



100% COPPER WIRE WINDING MOTOR



UNIQUE DESIGN

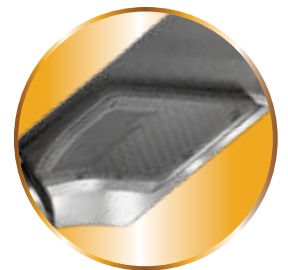

Unique 3D Trim

- Modern styling with tangential blades
- Decorative blade trims with 3D design pattern
- Superior paint finish

STAR RATING	SWEEP	POWER INPUT	SPEED	AIR DELIVERY
	1200 mm	55 W	370 r/min	222 m ³ /min



Dusk



Pearl White





EXTER



Midnight Black

Wider Blade Tip



Dual tone Blade Trim



- Nature inspired design with leaf shaped dual tone blade trim to keep you at peace
- Wide blade for High Air Delivery
- Rust Resistant



Smoke Brown

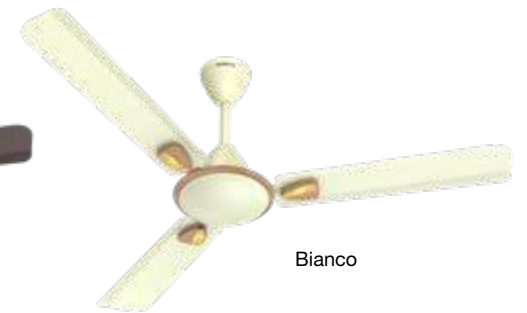

Bianco



White



Grey

STAR RATING	SWEEP	POWER INPUT	SPEED	AIR DELIVERY
	1200 mm	55 W	370 r/min	225 m ³ /min





ASTURA ES



- Decorative trims with foiling on blades & canopy
- Wider Blade With Dust resistant Metallic Paint Finish
- Robust motor with large diameter

STAR RATING	SWEEP	POWER INPUT	SPEED	AIR DELIVERY
	1200 mm	53 W	390 r/min	218 m ³ /min

Note: Dust resistant coating is applicable on glossy finish only.

Bianco Bronze



White Pearl Ivory



White Maroon



Brown Gold Mist





LEGANZA ES

4 BLADES



Unique 4 blade design



Wider Blade Tip

- Superior Metallic Paint Finish
- 4 blade innovative design with blade trim & Body ring

STAR RATING	SWEEP	POWER INPUT	SPEED	AIR DELIVERY
	1200 mm	52 W	350 r/min	215 m ³ /min



Note: Dust resistant coating is applicable on glossy finish only.



Mist Honey



Bronze Gold



Pearl White Silver



MILOR ES



Downrod cover



- Unique Design in Dust Resistant Premium metallic paint finish
- Premium Canopy set with Downrod Cover

Dusk



Pearl White



Gold

STAR RATING	SWEEP	POWER INPUT	SPEED	AIR DELIVERY
	1200 mm	55 W	390 r/min	222 m ³ /min





FESTIVA ES

Ocean Blue Silver



- Dust Resistant with metallic paint finish
- Decorative Trims on Blade & Canopy
- Robust motor with large diameter

STAR RATING	SWEEP	POWER INPUT	SPEED	AIR DELIVERY
	1200 mm	55 W	390 r/min	230 m ³ /min



Espresso Brown

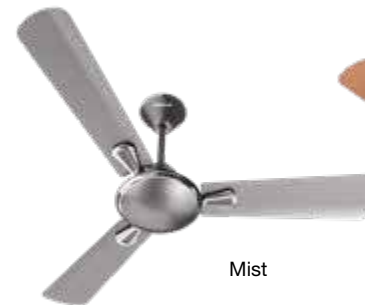

Mist



Pearl Copper Gold



Pearl Ivory



Pearl White Silver



Gold Mist

Note: Dust resistant coating is applicable on glossy finish only.



FUSION ES

Espresso Brown



Low Noise



- Dust Resistant with metallic paint finish
- Decorative Trims on Blade & Canopy



Pearl White Silver



Silver Blue



Beige Brown



Pearl Ivory Gold

STAR RATING	SWEEP	POWER INPUT	SPEED	AIR DELIVERY
	1200 mm	50 W	350 r/min	226 m ³ /min



Note: Dust resistant coating is applicable on glossy finish only.



QUICK AIR



- Wider Blade Tip for High Air Delivery
- UV metallized Body Ring and Trim for Enhanced Looks
- Robust motor with large diameter

STAR RATING	SWEEP	POWER INPUT	SPEED	AIR DELIVERY
	1400 mm	60 W	290 r/min	245 m ³ /min
	1200 mm	56 W	380 r/min	225 m ³ /min
	900 mm	42 W	420 r/min	140 m ³ /min
	600 mm	60 W	800 r/min	100 m ³ /min



Matt Blue



Desert Gold



White



Bianco



Smoke Brown



ANDRIA ES



High Air Delivery



Low Noise

- Modern design to suit contemporary interiors
- Ribbed blade for high air delivery & air thrust

STAR RATING	SWEEP	POWER INPUT	SPEED	AIR DELIVERY
	1200 mm	57 W	380 r/min	230 m ³ /min



Quartz



Indigo Blue



Pearl White



Espresso Brown





NICOLA ES



High Air Delivery



Low Noise



Wider Blade Tip



- Contemporary elegant design in metallic paint finish
- Decorative trims on motor cover & blades

STAR RATING	SWEEP	POWER INPUT	SPEED	AIR DELIVERY
	1200 mm	57 W	380 r/min	230 m ³ /min



Gold Mist Copper



Bronze Copper



Pearl Ivory Gold

Pearl White Silver



FUSION PRIME ES



High Air Delivery



- Broad blades with elegant trims
- Stylish canopies with unique downrod cover

Beige Brown



Mist Espresso Brown



Pearl Ivory Gold



Espresso Brown Cola Copper



Pearl White LT Copper



Matt Black



Pearl Ivory Beige

STAR RATING	SWEEP	POWER INPUT	SPEED	AIR DELIVERY
	1200 mm	52 W	350 r/min	220 m ³ /min





COMFORT AIR DECO

Wider Blade Tip



- Metallic Paint Finish
- Hi speed motor for better air thrust
- Decorative Ring at Bottom Cover
- Decorative Trim on Blades

Pearl White Lt. Copper



Bronze Cola Copper

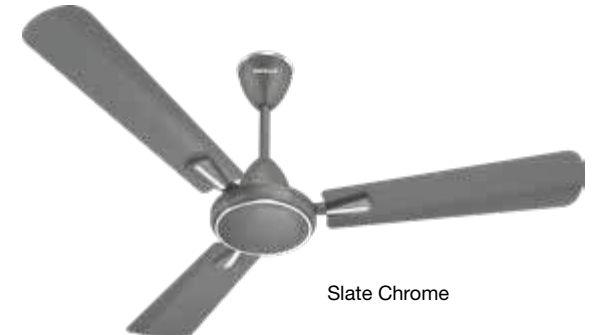

Slate Chrome

STAR RATING	SWEEP	POWER INPUT	SPEED	AIR DELIVERY
	1200 mm	53 W	350 r/min	218 m ³ /min





DROVE DECO



Wider
Blade
Tip



- Powder Coated Finish
- Hi speed motor for better air thrust
- Wider Blade for Better Air Delivery
- Decorative lining at Bottom Cover
- Decorative Trim on Blades

STAR RATING	SWEEP	POWER INPUT	SPEED	AIR DELIVERY
	1200 mm	53 W	390 r/min	218 m ³ /min



Elegant White



Matt Blue



Smoke Brown





LOOK UP TO
**REGULAR
FANS**





SS 390 METALLIC ES



- Wide Blade Tip for Effective Air Circulation
- Aerodynamically Designed blades for High Air Delivery

STAR RATING	SWEEP	POWER INPUT	SPEED	AIR DELIVERY
	1400 mm	60 W	290 r/min	250 m ³ /min
	1200 mm	55 W	390 r/min	230 m ³ /min
	900 mm	42 W	420 r/min	140 m ³ /min
	600 mm	60 W	800 r/min	100 m ³ /min



Pearl White



Sparkle Brown



Pearl Brown



Pearl Ivory Gold



SS 390 ES



- Wide Blade Tip for Effective Air Circulation
- Aerodynamic Designed blades for High Air Delivery

STAR RATING	SWEEP	POWER INPUT	SPEED	AIR DELIVERY
	1400 mm	60 W	290 r/min	250 m ³ /min
	1200 mm	55 W	390 r/min	230 m ³ /min
	900 mm	42 W	420 r/min	140 m ³ /min
	600 mm	60 W	800 r/min	100 m ³ /min

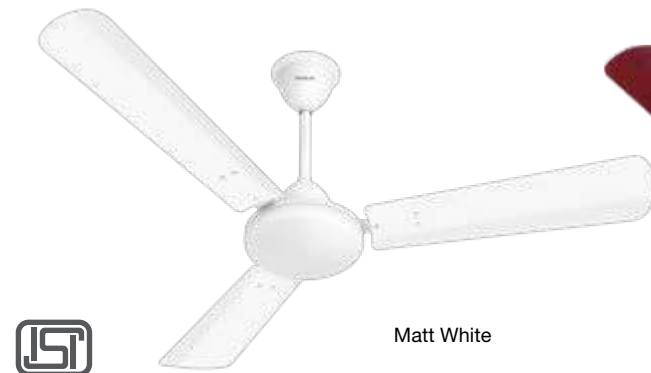

Matt White

Bianco

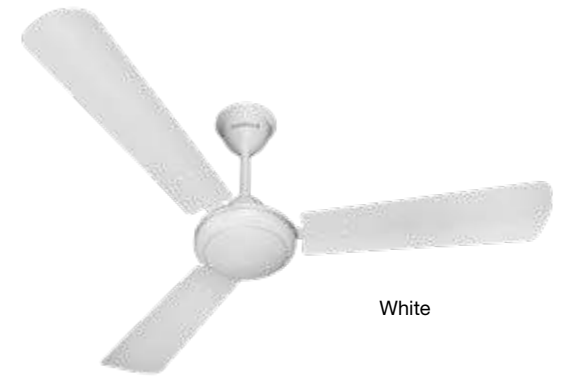

White



Brown



ES 40



Low Noise



Wide Motor



Wider Blade Tip

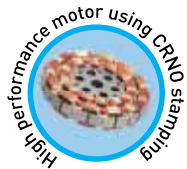

- Aerodynamic Blades for maximum Air delivery
- Energy Efficient 3 star rating

Comparison between ES-40 with ordinary fans		
Parameter & Criteria	ES-40	Ordinary Fans
Rated Wattage	40 W*	75 W
Energy Consumption @ 16 hours / day	0.640 kWh (0.64 Units)	1.2 kWh (1.2 Units)
Total Consumption of Electricity / Month	19 kWh (12 units)	36 kWh (36 units)
Cost of Electricity / Month @ ₹ 7.00* per kWh (Rs. 7.00 per unit)	₹ 133.00	₹ 252.00

Calculation based on average usage & cost of electricity for 1200 mm sweep
Wattage may vary upto 5% * Cost of electricity may vary from location to location

STAR RATING	SWEEP	POWER INPUT	SPEED	AIR DELIVERY
	1200 mm	40 W	300 r/min	212 m ³ /min



Bianco



Brown



White



SAMRAAT ES

Brown



- Aerodynamically designed Aluminium Blades for Better Air Spread
- Elegant Design & High-Speed Performance

STAR RATING	SWEEP	POWER INPUT	SPEED	AIR DELIVERY
	1400 mm	60 W	290 r/min	250 m ³ /min
	1200 mm	55 W	390 r/min	230 m ³ /min
	900 mm	42 W	420 r/min	140 m ³ /min
	600 mm	60 W	800 r/min	100 m ³ /min



White

Bianco





THRILL AIR ES



- High Speed optimum Air Delivery
- Long Lasting paint finish



Brown

Smoke Brown

Matt Blue

Bianco

Sea Green

Grey

White

STAR RATING	SWEEP	POWER INPUT	SPEED	AIR DELIVERY
	1200 mm	52 W	390 r/min	215 m ³ /min





SPEEDSTER HS



High Air Delivery



HIGH SPEED



- Sleek design to enhance room decor
- High Speed motor ensures high air thrust
- Rust Resistant
- Perfect for underground parking, kitchen, shop & small room

STAR RATING	SWEEP	POWER INPUT	SPEED	AIR DELIVERY
	900 mm	52 W	650 r/min	165 m ³ /min



Brown



White



Bianco



XPRESS AIR

Wider Blade Tip



Low Noise



Aluminium Blade

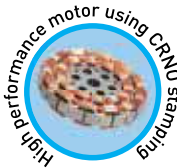

- Sleek motor for elegant room aesthetics
- Aerodynamic and wide blade tip for high air delivery

STAR RATING	SWEEP	POWER INPUT	SPEED	AIR DELIVERY
	1400 mm	60 W	290 r/min	250 m ³ /min
	1200 mm	55 W	370 r/min	230 m ³ /min
	900 mm	42 W	420 r/min	140 m ³ /min
	600 mm	60 W	800 r/min	100 m ³ /min



Brown



Matt Black



Desert Gold



Glossy White



Matt White



Bianco



ES PLUS

Brown

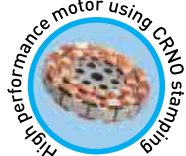

- Ergonomic design with optimum Air Delivery
- Energy Efficient 2 star rating



Bianco

STAR RATING	SWEEP	POWER INPUT	SPEED	AIR DELIVERY
	1200 mm	50 W	350 r/min	226 m ³ /min





SPEEDSTER HS

Brown



Unique 4 blade design



- Aerodynamically designed blades for High Performance
- Superior air delivery even at low voltage



White

STAR RATING	SWEEP	POWER INPUT	SPEED	AIR DELIVERY
	600 mm	65 W	800 r/min	100 m ³ /min



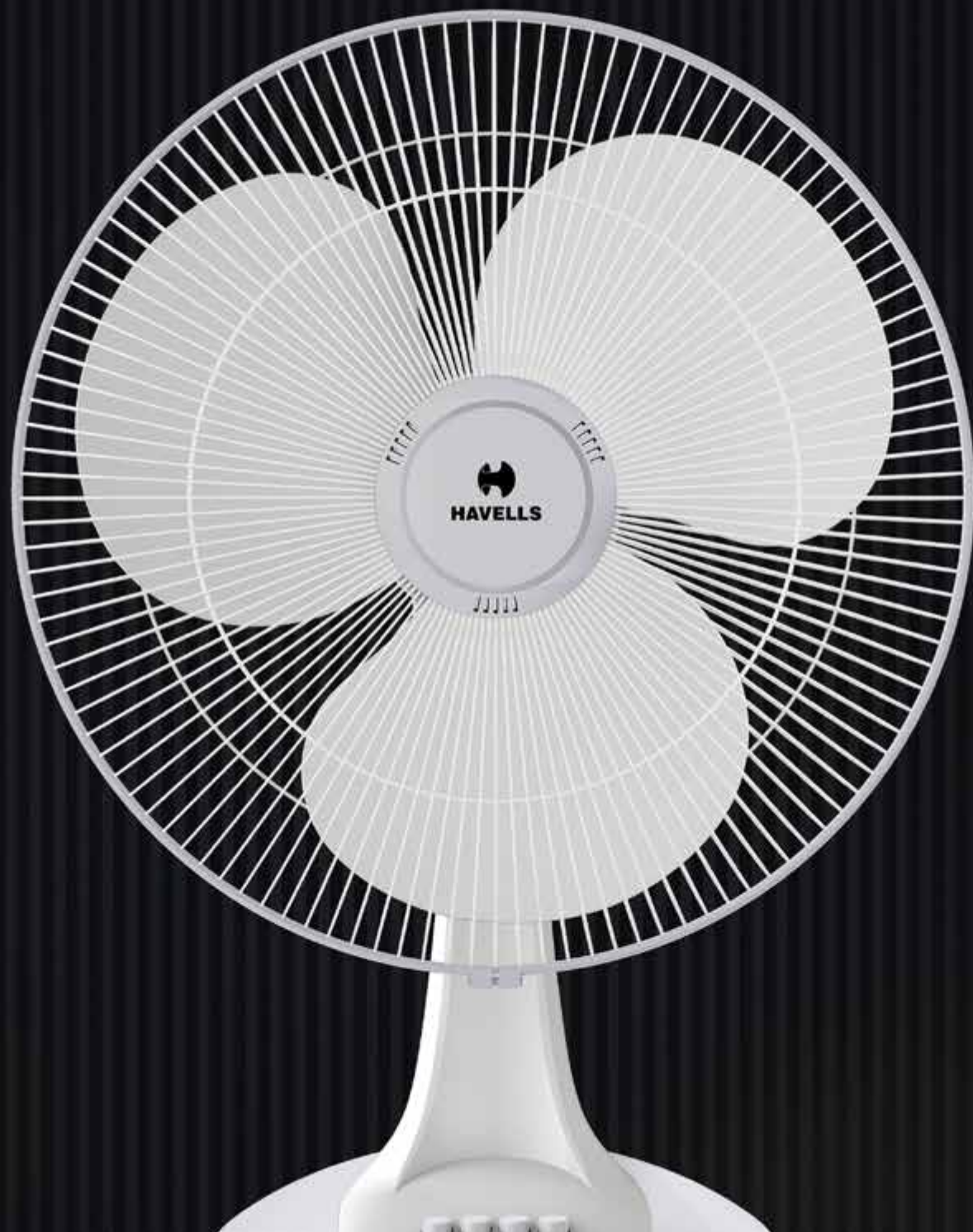
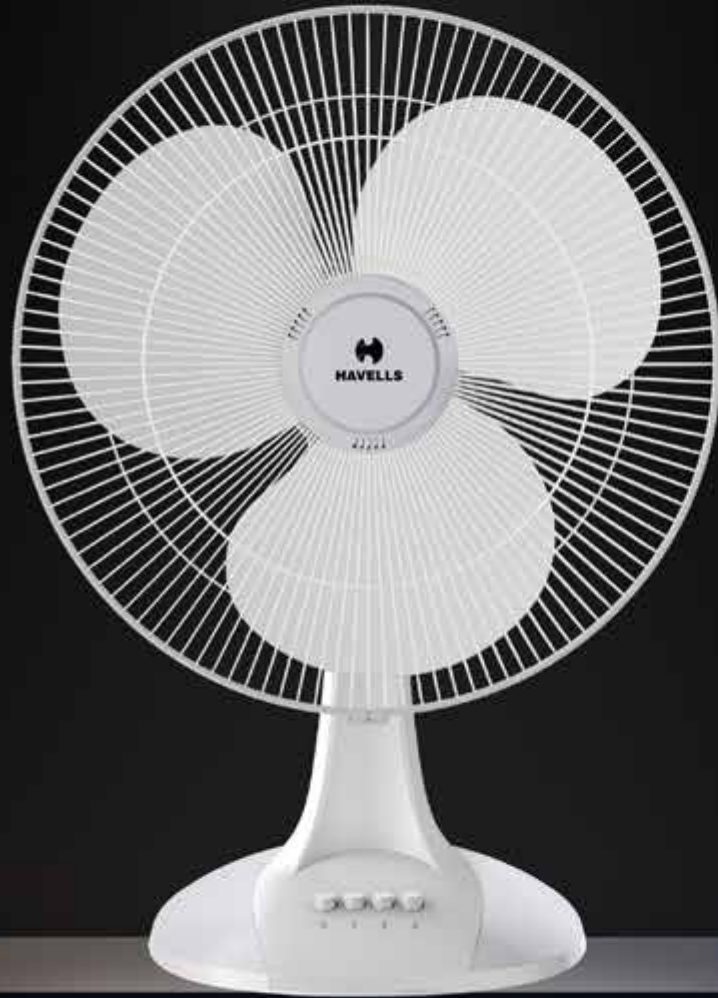

TABLE FANS







SWING LX HS

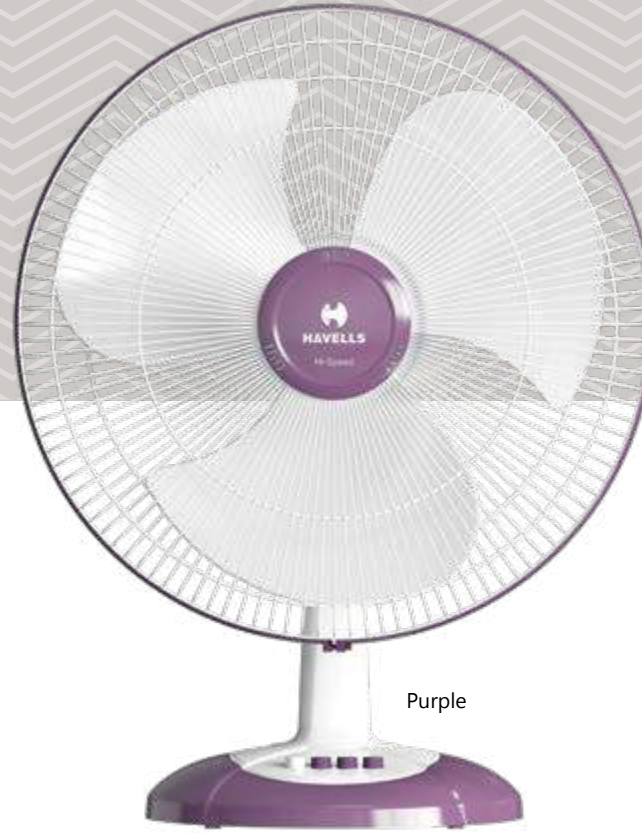

Purple

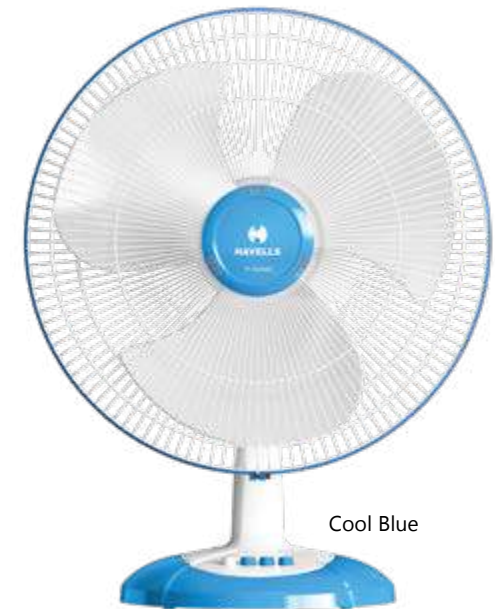

Cool Blue



Double Ball Bearing

- High speed motor for better air delivery
- Smooth oscillation
- Superior performance at low voltage
- Double ball bearing for noiseless operation

STAR RATING	SWEEP	POWER INPUT	SPEED	AIR DELIVERY
NA	400 mm	125 W	2100 r/min	95 m ³ /min





SWING LX



Cherry



- Smooth oscillation
- Pivot arrangement for tilting & oscillation
- Aerodynamically designed & balanced PP blades

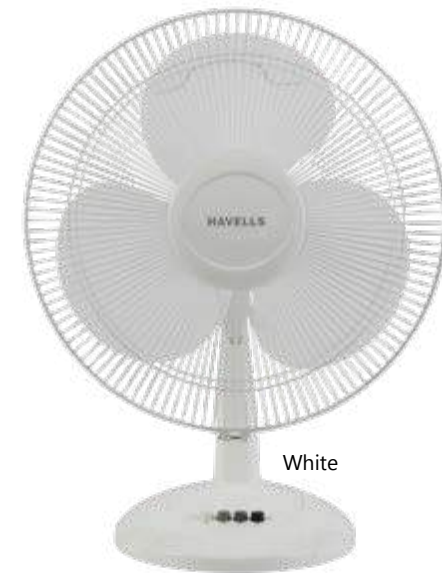

White

STAR RATING	SWEEP	POWER INPUT	SPEED	AIR DELIVERY
NA	400 mm	55 W	1350 r/min	65 m ³ /min





SAMEERA

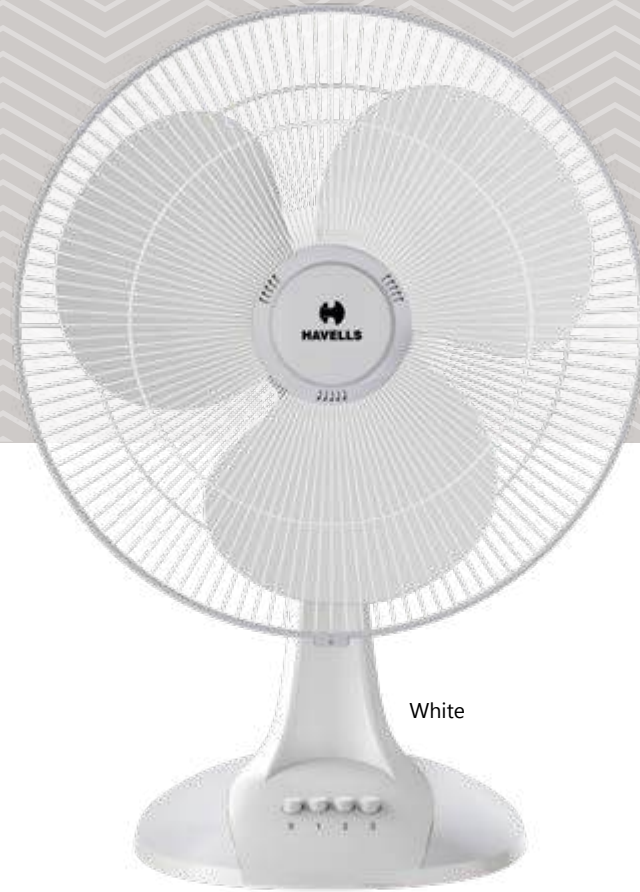

White

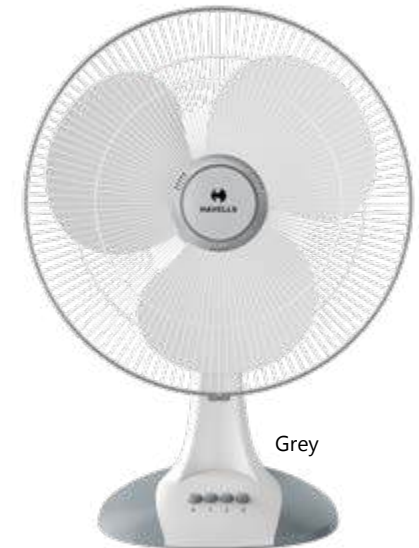

Grey

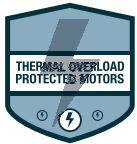

- Smooth oscillation
- Pivot arrangement for tilting & oscillation
- Aerodynamically designed & balanced PP blades

STAR RATING	SWEEP	POWER INPUT	SPEED	AIR DELIVERY
NA	400 mm	57 W	1350 r/min	65 m ³ /min



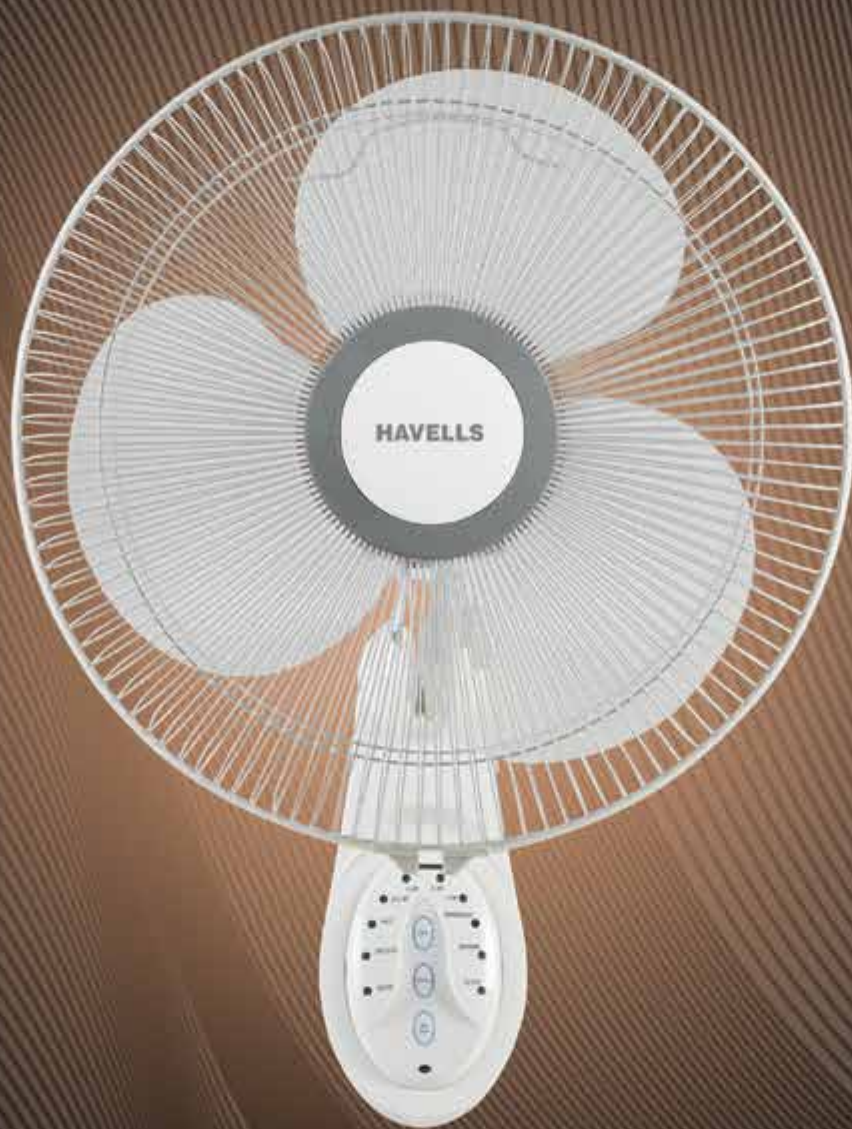



WALL
FANS



GIRIK GOLD

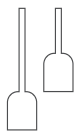

Pull cord for Speed
& Oscillation

- Wooden texture body to complement room decor
- Golden guards & trim for premium look
- Pull cord for On/Off, Speed & Oscillation
- Smooth oscillation

STAR RATING	SWEEP	POWER INPUT	SPEED	AIR DELIVERY
NA	400 mm	57 W	1350 r/min	65 m ³ /min



Gold

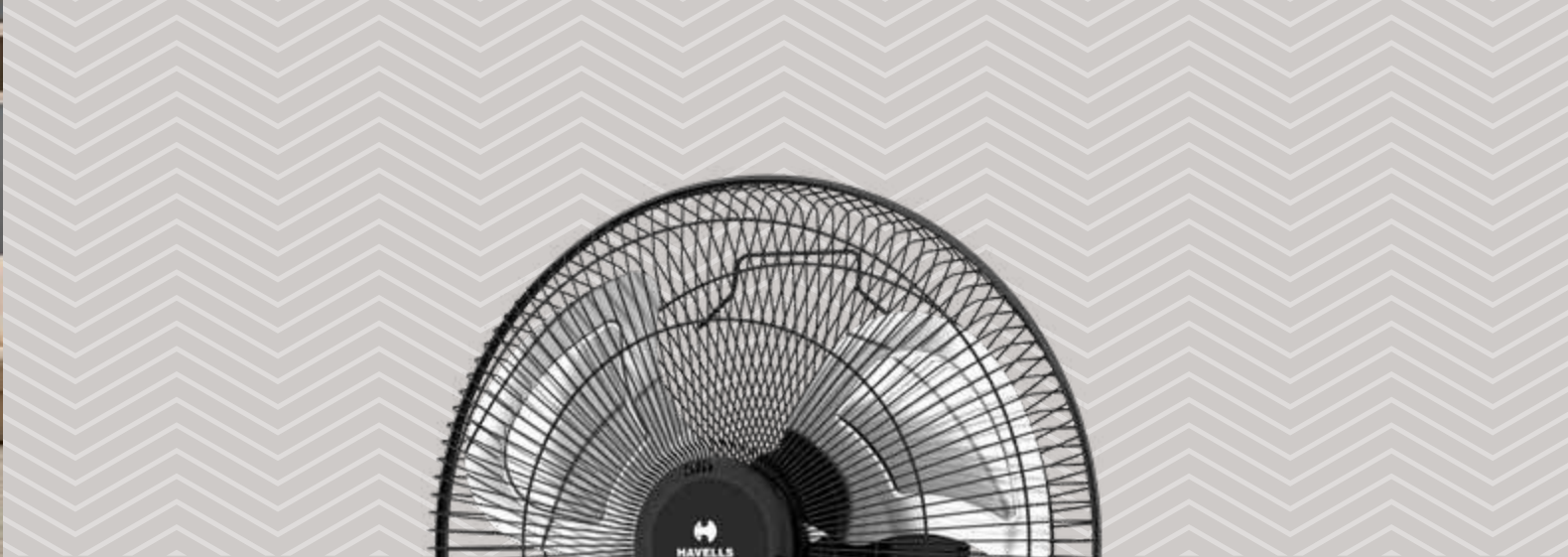

GIRIK NEO

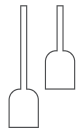
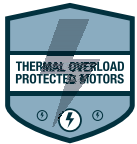

Pull cord for Speed & Oscillation

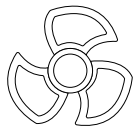

Metal blades with ribs



Rust Proof Aluminium Blades

- Sturdy & heavy duty aluminium blades for high air delivery
- Sleek & stylish design
- Smooth oscillation
- Rust free ribbed aluminium blade
- 3 speed regulation

Black

STAR RATING	SWEEP	POWER INPUT	SPEED	AIR DELIVERY
NA	400 mm	57 W	1350 r/min	70 m ³ /min





AINDRILA



Brown Black

- Timer Setting Upto 8 hours
- Remote control operation
- Soft touch panel for manual operation
- ABS body for high strength and gloss
- Standard, Natural, Breeze & Sleep Mode
- Additional fuse for protection against high voltage & spikes
- Smooth oscillation
- Square guard design for premium looks

STAR RATING	SWEEP	POWER INPUT	SPEED	AIR DELIVERY
NA	400 mm	57 W	1350 r/min	65 m ³ /min





PLATINA BLDC



Low Noise



Low Power Consumption



Sturdy and Well-built



Double Ball Bearing



BLDC INVERTER TECHNOLOGY



Yellow



- Sturdy and well built design
- High performance motor for better air delivery
- Smooth oscillation
- Aerodynamically designed & balanced heavy duty PP blades
- Low voltage protection
- Remote with breeze and sleep mode along with timer setting upto 8 hours

STAR RATING	SWEEP	POWER INPUT	SPEED	AIR DELIVERY
	400 mm	30 W	1350 r/min	65 m ³ /min





PLATINA REMOTE



- Smooth oscillation with synchronous motor
- I.R. remote control
- High performance motor
- Aerodynamically designed & balanced heavy duty PP blades

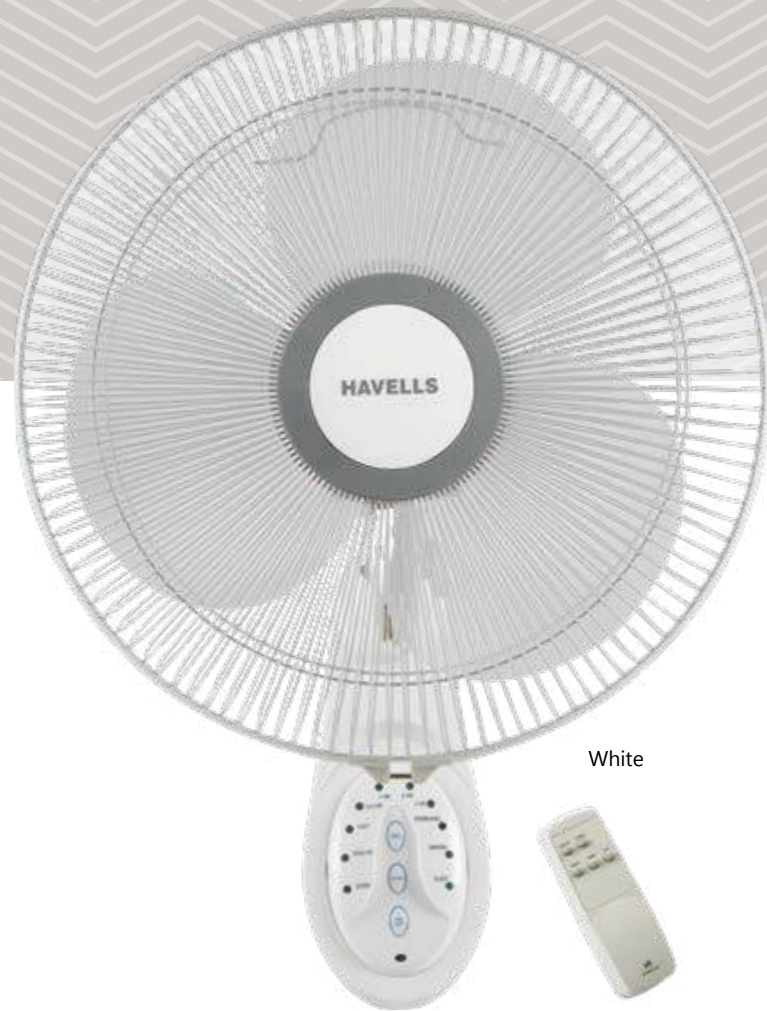

White

STAR RATING	SWEEP	POWER INPUT	SPEED	AIR DELIVERY
NA	400 mm	57 W	1350 r/min	65 m ³ /min





PLATINA - HS



Double Ball Bearing

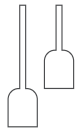

Pull cord for Speed & Oscillation

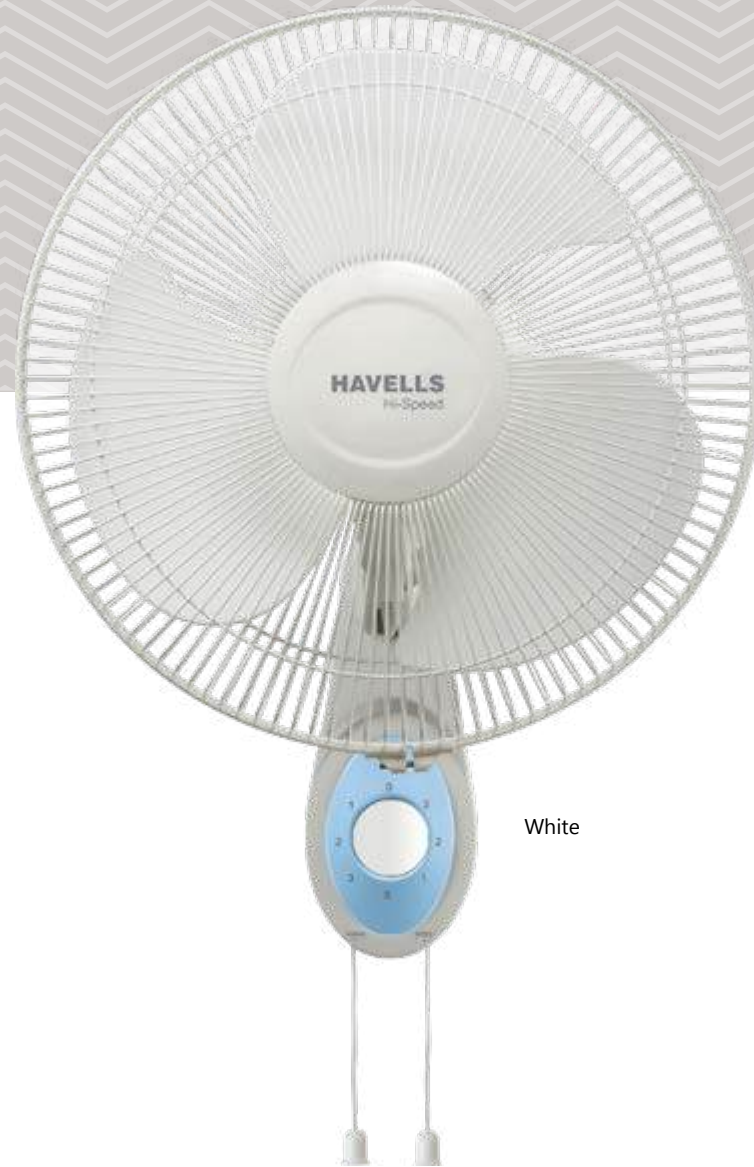

White

- Smooth oscillation
- Aerodynamically designed balanced heavy duty PP blades
- Double ball bearing for noiseless operation

STAR RATING	SWEEP	POWER INPUT	SPEED	AIR DELIVERY
	400 mm	125 W	2100 r/min	95 m ³ /min





PLATINA

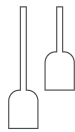

Pull cord for Speed & Oscillation

- High performance motor for better air delivery
- Smooth oscillation
- Aerodynamically designed & balanced heavy duty PP blades



White

STAR RATING	SWEEP	POWER INPUT	SPEED	AIR DELIVERY
NA	400 mm	57 W	1350 r/min	65 m ³ /min





MARVEL WIND HS



Double Ball Bearing

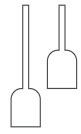

Pull cord for Speed & Oscillation



HIGH SPEED



- High performance motor for better air delivery
- Smooth oscillation
- Aerodynamically designed & balanced heavy duty PP blades
- Double ball bearing for noiseless operation

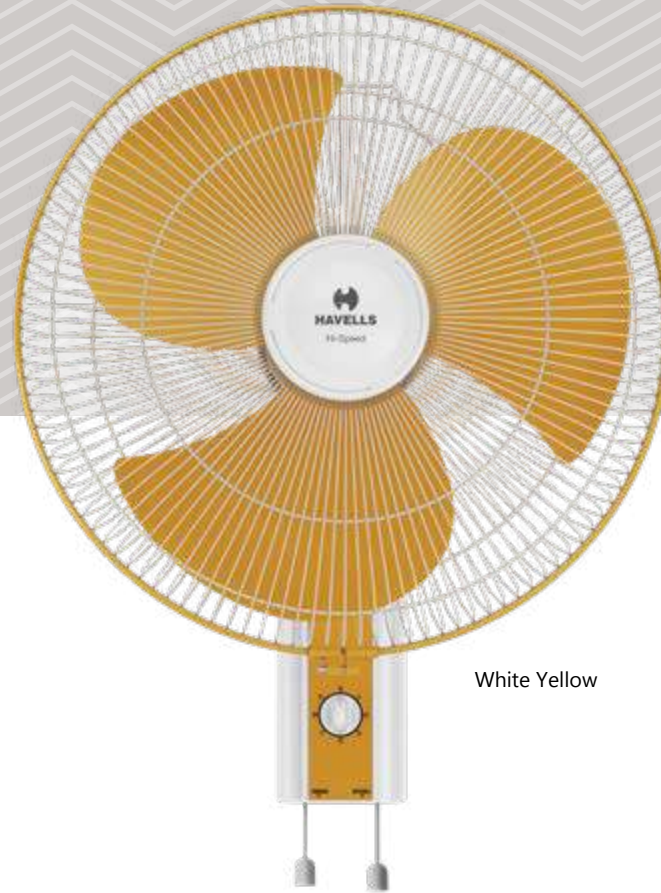

White Yellow

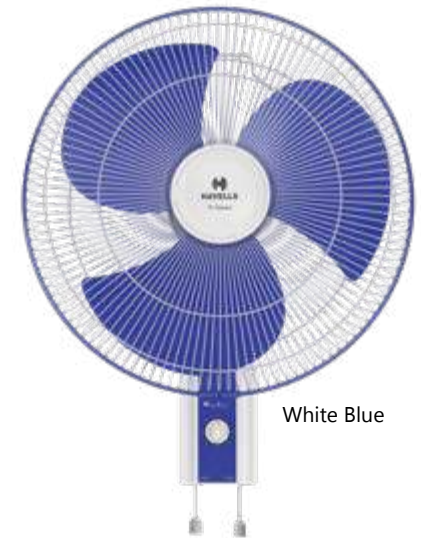

White Blue

STAR RATING	SWEEP	POWER INPUT	SPEED	AIR DELIVERY
NA	400 mm	125 W	2100 r/min	95 m ³ /min



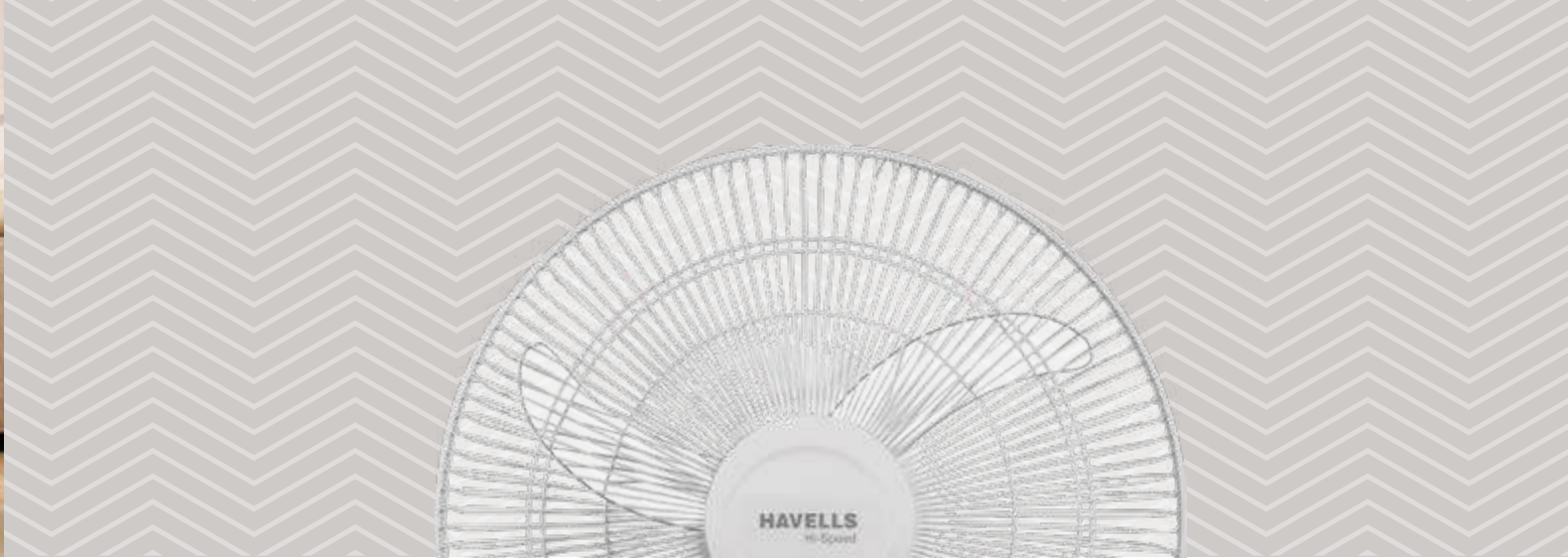

AIRBOLL-HS



Double Ball Bearing

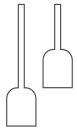

Pull cord for Speed & Oscillation



- Smooth oscillation
- Aerodynamically designed & balanced propeller type blades
- Double ball bearing for noiseless operation
- Transparent blades for aesthetics

White

STAR RATING	SWEEP	POWER INPUT	SPEED	AIR DELIVERY
NA	450 mm	110 W	1750 r/min	100 m ³ /min





PENTAFORCE

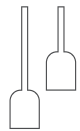

Pull cord for Speed & Oscillation

- Smooth oscillation
- Aerodynamically designed & balanced propeller type blades

STAR RATING	SWEEP	POWER INPUT	SPEED	AIR DELIVERY
NA	400 mm	65 W	1350 r/min	70 m ³ /min



Grey Wine

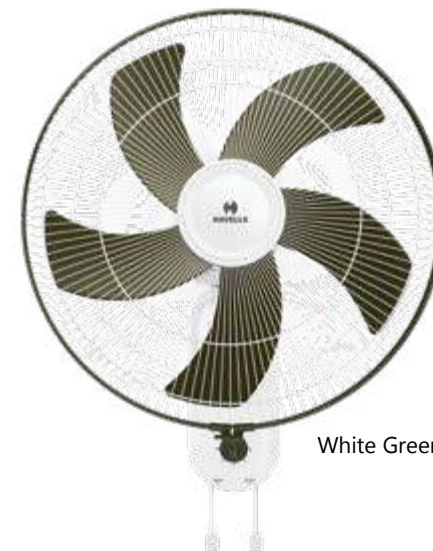

White Green



D'ZIRE HS



Double Ball Bearing

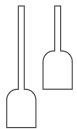

Pull cord for Speed & Oscillation

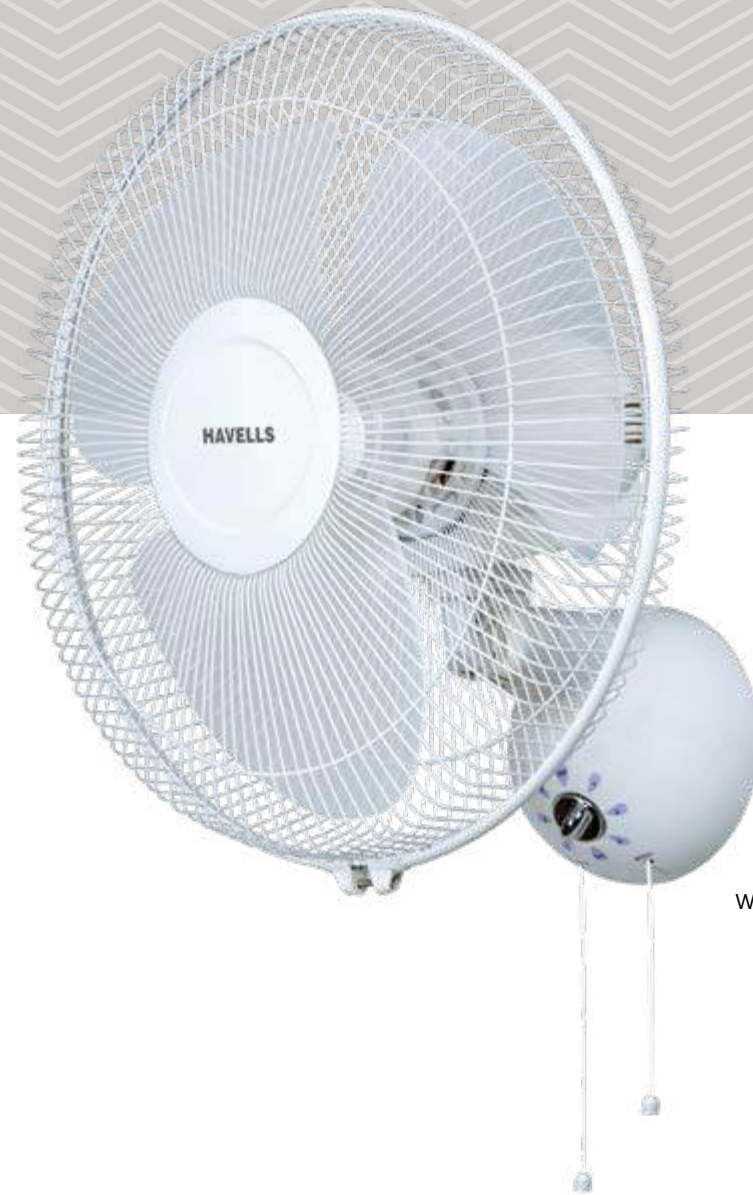

White

- Elegantly designed fan base in round shape
- Contemporary look
- Double ball bearing for noiseless operation
- Smooth oscillation

STAR RATING	SWEEP	POWER INPUT	SPEED	AIR DELIVERY
NA	300 mm	105 mm	2000 r/min	65 m ³ /min





D'ZIRE

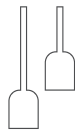

Pull cord for Speed & Oscillation

- Elegantly designed fan base in round shape
- Stylish contemporary look
- Pull cord control for speed & oscillation
- Smooth oscillation



Grey

STAR RATING	SWEEP	POWER INPUT	SPEED	AIR DELIVERY
NA	400 mm	57 W	1350 r/min	65 m ³ /min
NA	300 mm	57 W	1350 r/min	52 m ³ /min





SWING - HS



Double Ball Bearing

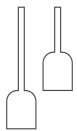

Pull cord for Speed & Oscillation



- Elegantly designed fan base
- Pull cord control for speed & oscillation On-Off
- Aerodynamically designed & balanced blades
- Smooth oscillation

STAR RATING	SWEEP	POWER INPUT	SPEED	AIR DELIVERY
NA	400 mm	125 W	2100 r/min	95 m ³ /min
NA	300 mm	105 W	2100 r/min	65 m ³ /min

Note : 300 mm is available in white color only.

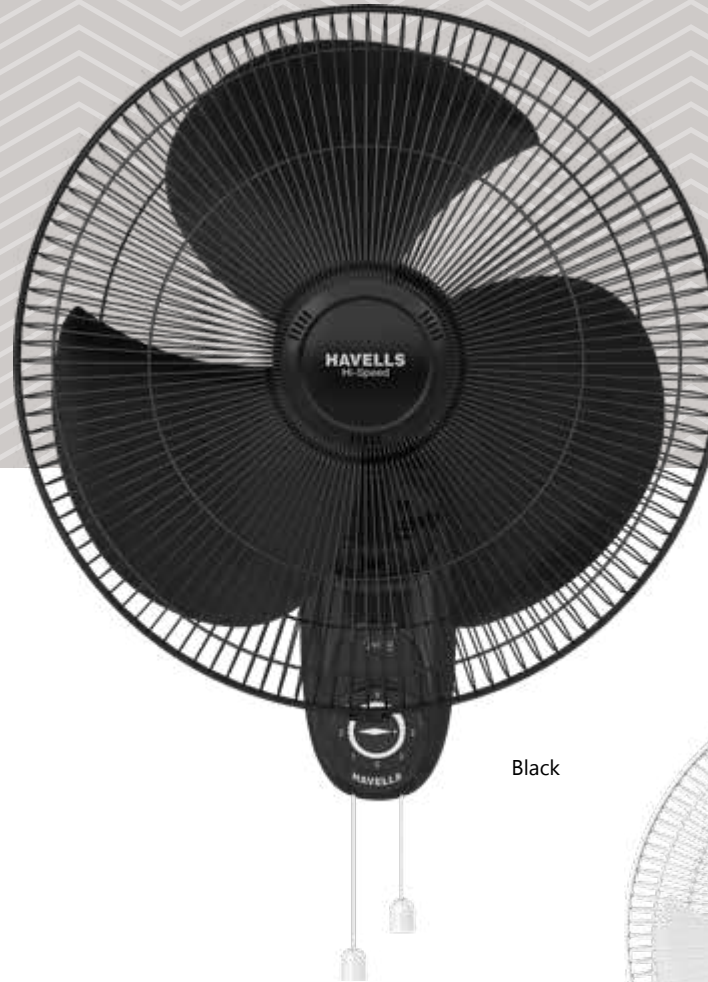

Black

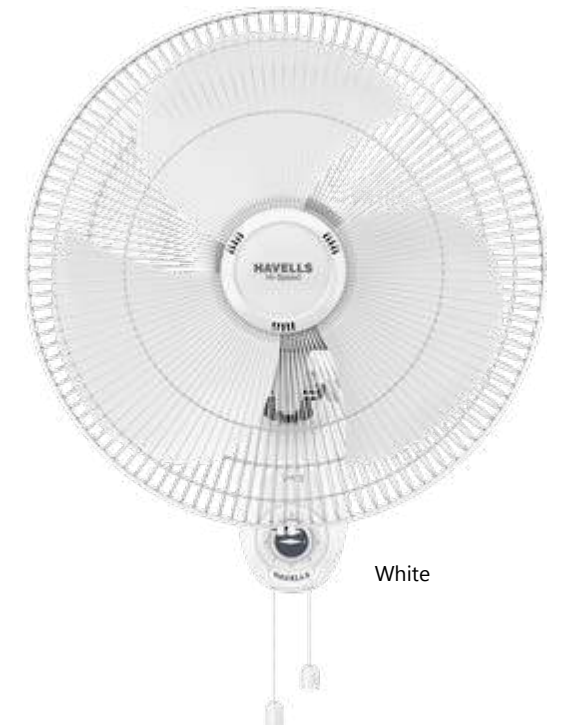

White



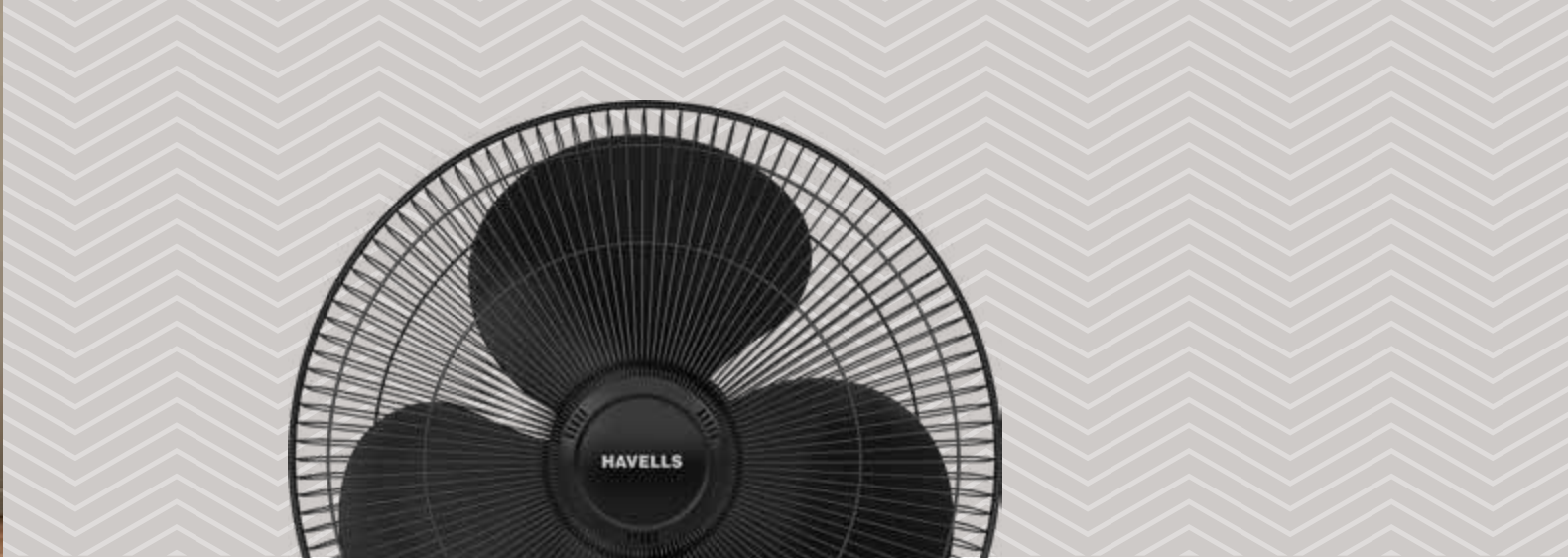

SWING

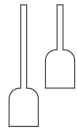

Pull cord for Speed & Oscillation

- Elegantly designed fan base
- Pull cord control for speed & oscillation On-Off
- Aerodynamically designed balanced blades
- Smooth oscillation

STAR RATING	SWEEP	POWER INPUT	SPEED	AIR DELIVERY
	400 mm	57 W	1350 r/min	65 m ³ /min
NA	300 mm	57 W	1350 r/min	52 m ³ /min

Note : 300 mm is available in off white color only.

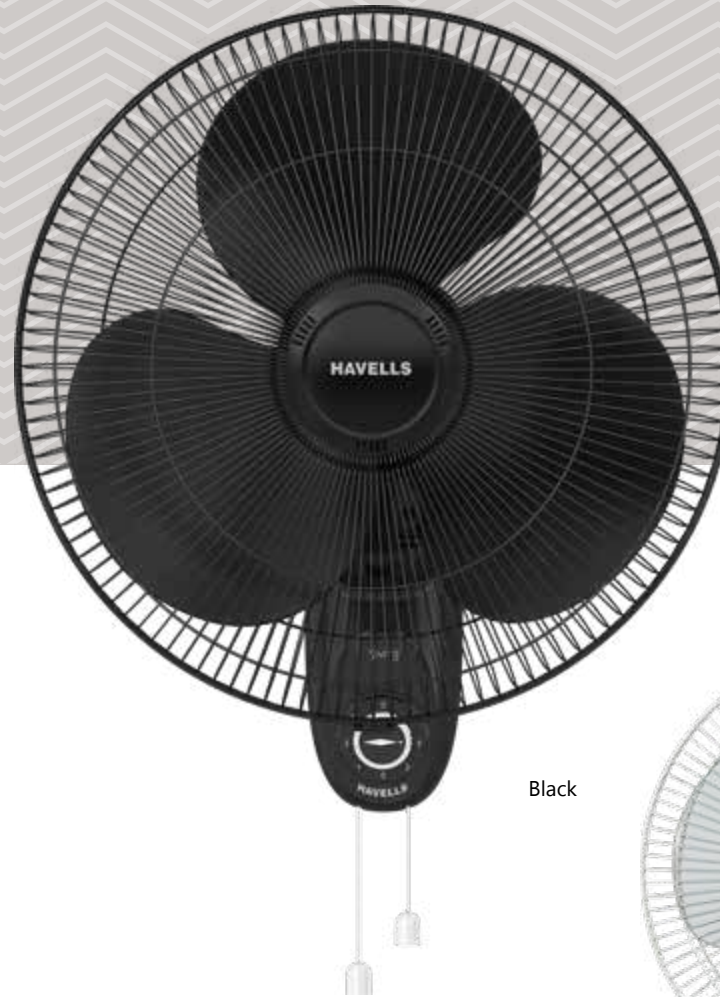

Black

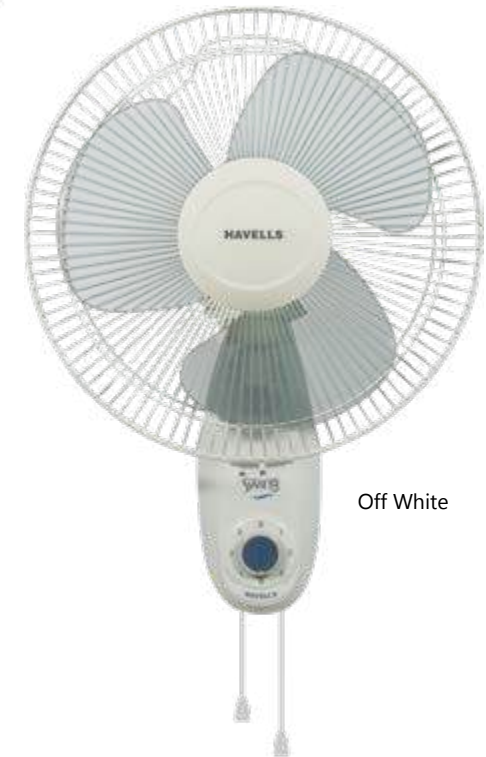

Off White



SAMEERA

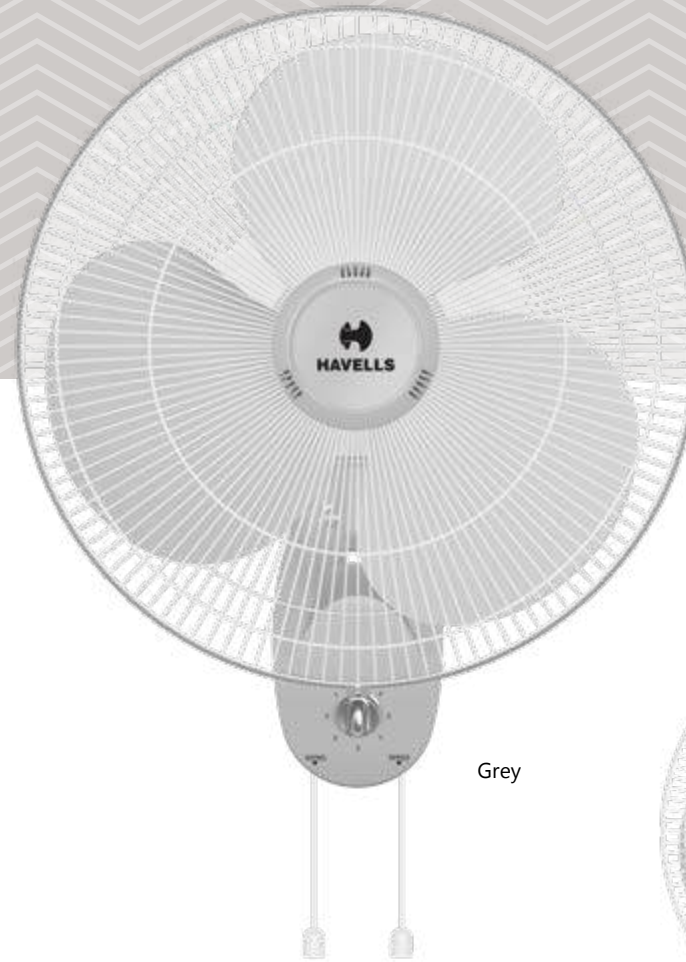

Grey

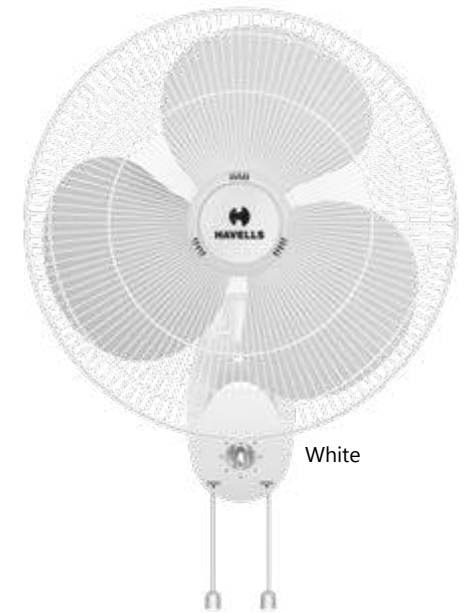

White

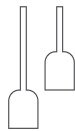

Pull cord for Speed & Oscillation

- Elegant looks
- High Air Delivery
- Attractive colour combinations
- Smooth oscillation

STAR RATING	SWEEP	POWER INPUT	SPEED	AIR DELIVERY
NA	400 mm	57 W	1350 r/min	65 m ³ /min





V2 NEO WALL



Black Chrome



Rust Proof
Aluminium
Blades

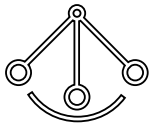

Motorized
oscillation



THERMAL OVERLOAD
PROTECTED MOTORS



100%
COPPER WIRE
WINDING MOTOR

- High structural stability
- Strong motor for High Air Delivery
- Superior performance even at Low voltage
- Aerodynamically designed rust proof aluminium blades
- Speed independent smooth & constant oscillations

STAR RATING	SWEEP	POWER INPUT	SPEED	AIR DELIVERY
NA	450 mm	100 W	1380 r/min	110 m ³ /min





V3



Rust Proof
Aluminium
Blades

Black Chrome

- Aerodynamically designed rust proof aluminium blades
- Heavy base for stability
- Sturdy & heavy duty aluminium blades for high air delivery
- Sleek & stylish design
- Smooth oscillation

STAR RATING	SWEEP	POWER INPUT	SPEED	AIR DELIVERY
NA	450 mm	100 W	1350 r/min	110 m ³ /min









LIFESTYLE
FANS

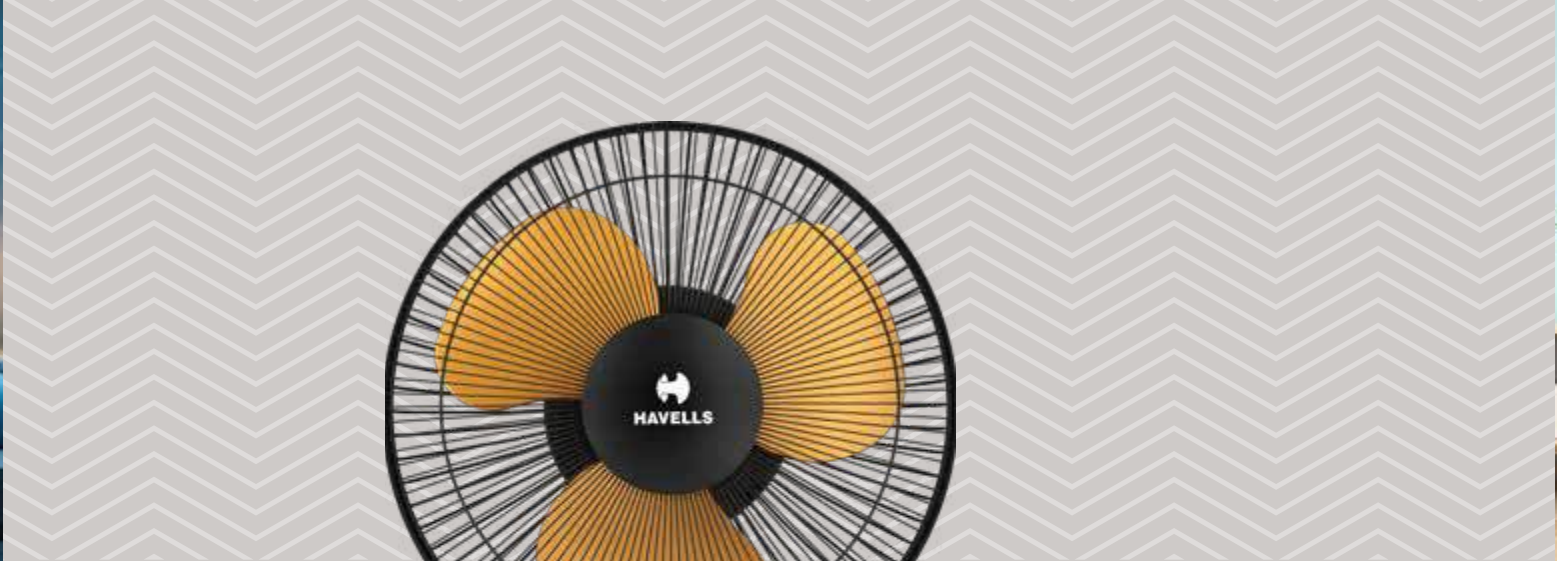

CANDY

Black Yellow



3 Speed Control

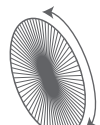

Swing Feature

Wide Tilt Angle

- Multi purpose fan for table & wall mounting
- High Speed Fan with swing feature and wide tilt angle for breezy feel

STAR RATING	SWEEP	POWER INPUT	SPEED	AIR DELIVERY
NA	230 mm	60 W	2700 r/min	35 m ³ /min



Black Red



SQU' AIR



Silent Fan



Runs on USB



No Battery required



360 degree Rotation



- Personal mini multi purpose fan
- 3 speed control
- High air flow
- Easy to carry

STAR RATING	SWEEP	POWER INPUT	SPEED
NA	100 mm	4 W	1300 r/min



Coral



Indigo blue



CIERA HS



Off White



- Grill for protection
- Ideal for mounting on low height ceiling and in cabin

STAR RATING	SWEEP	POWER INPUT	SPEED	AIR DELIVERY
NA	230 mm	60 W	2700 r/min	60 m ³ /min
NA	300 mm	85 W	2200 r/min	75 m ³ /min



White





GYRO



White

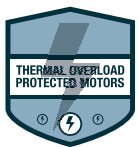

- 360° gyroscopic movement / adjustable wind direction
- Grill for protection
- Ideal for mounting on low height ceiling
- Aerodynamically designed balanced ABS blades

STAR RATING	SWEEP	POWER INPUT	SPEED	AIR DELIVERY
NA	400 mm	60 W	1350 r/min	65 m ³ /min



AIRWYNN

White



- Grill for protection
- Ideal for mounting on low height ceiling and in cabin
- Cabin fan
- Rotating grill for air circulation

STAR RATING	SWEEP	POWER INPUT	SPEED	AIR DELIVERY
NA	300 mm	80 W	2200 r/min	60 m ³ /min





CRESCENT



Yellow Blue



White Blue



- Revolving grill for wide spread of air
- Table and wall mounting - dual purpose
- 3 speed operation
- 180° fan head movement
- Super silent operation

STAR RATING	SWEEP	POWER INPUT	SPEED	AIR DELIVERY
NA	250 mm	45 W	1320 r/min	50 m ³ /min



I COOL- HS



White Maroon



Black Grey

- Unique multi-directional adjustment for desired air flow
- Unique propeller, deep pitched blades for powerful air flow
- Super multi purpose fan can be mounted on table, wall & ceiling

STAR RATING	SWEEP	POWER INPUT	SPEED	AIR DELIVERY
NA	175 mm	55 W	2000 r/min	40 m ³ /min



On wall



On Table



On Ceiling



BIRDIE HS



Yellow Maroon



Black Grey



- Jerk free oscillation and smooth running
- Multi use fan suitable for desk, wall or cabin mounted application
- Strong air blast

STAR RATING	SWEEP	POWER INPUT	SPEED	AIR DELIVERY
NA	230 mm	40 W	2800 r/min	38 m ³ /min



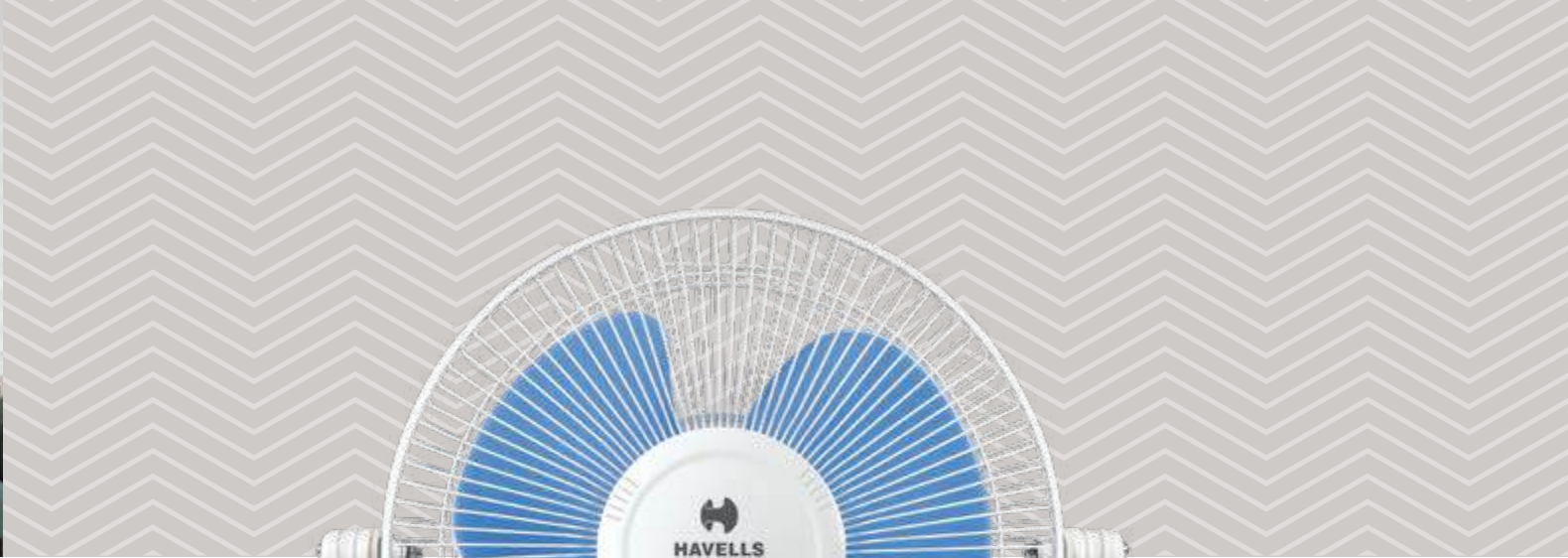

BREEZO - HS



White Blue



- High Speed & High air thrust
- Multipurpose - Can be used as Desk fan or Wall fan
- Three speed control

STAR RATING	SWEEP	POWER INPUT	SPEED	AIR DELIVERY
NA	300 mm	80 W	2200 r/min	60 m ³ /min









PEDESTAL FANS



AINDRILA PREMIUM



- Square Guard Design for Premium Looks
- Timer Upto 8 hours
- LED Light at the Bottom
- Sleep Mode and Breeze Mode
- Soft touch option for manual operation
- ABS body for high strength and gloss

STAR RATING	SWEEP	POWER INPUT	SPEED	AIR DELIVERY
NA	400 mm	57 W	1350 r/min	65 m ³ /min



Brown Black



SPRINT-18 HS



White



Double Ball Bearing

- High air delivery
- Smooth oscillation
- Heavy base for stability
- Double ball bearing for noiseless operation

STAR RATING	SWEEP	POWER INPUT	SPEED	AIR DELIVERY
NA	450 mm	125 W	2100 r/min	100 m ³ /min



NOTE: Model also available in normal speed variant.

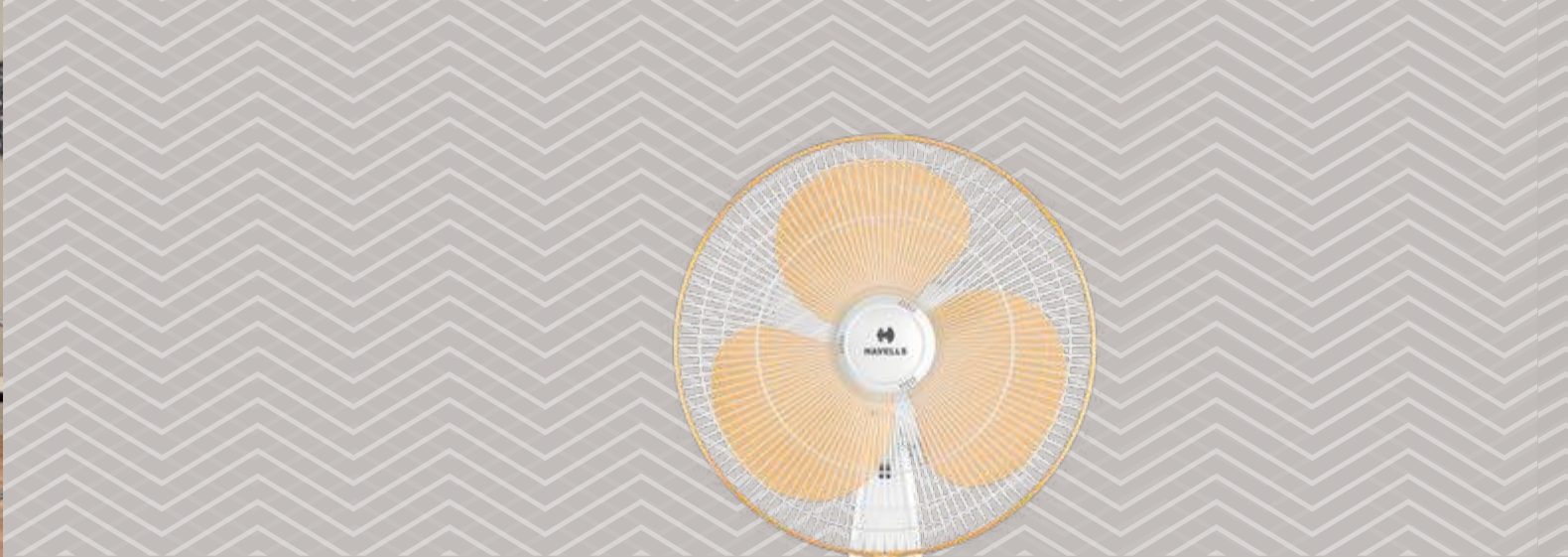

SPRINT BLDC



Low Noise



Low Power Consumption



Sturdy and Well-built



BLDC INVERTER TECHNOLOGY

- Attractive bi-colour metallic finish
- Telescopic height adjustment
- Wide oscillation
- Sturdy base for stability

STAR RATING	SWEEP	POWER INPUT	SPEED	AIR DELIVERY
	400 mm	30 W	1350 r/min	65 m ³ /min



White Yellow



SPRINT LED REMOTE



- Sturdy base for stability
- LED indicator lights
- Available in two attractive color combinations

STAR RATING	SWEEP	POWER INPUT	SPEED	AIR DELIVERY
	400 mm	57 W	1350 r/min	65 m ³ /min

Note : Model also available without remote.

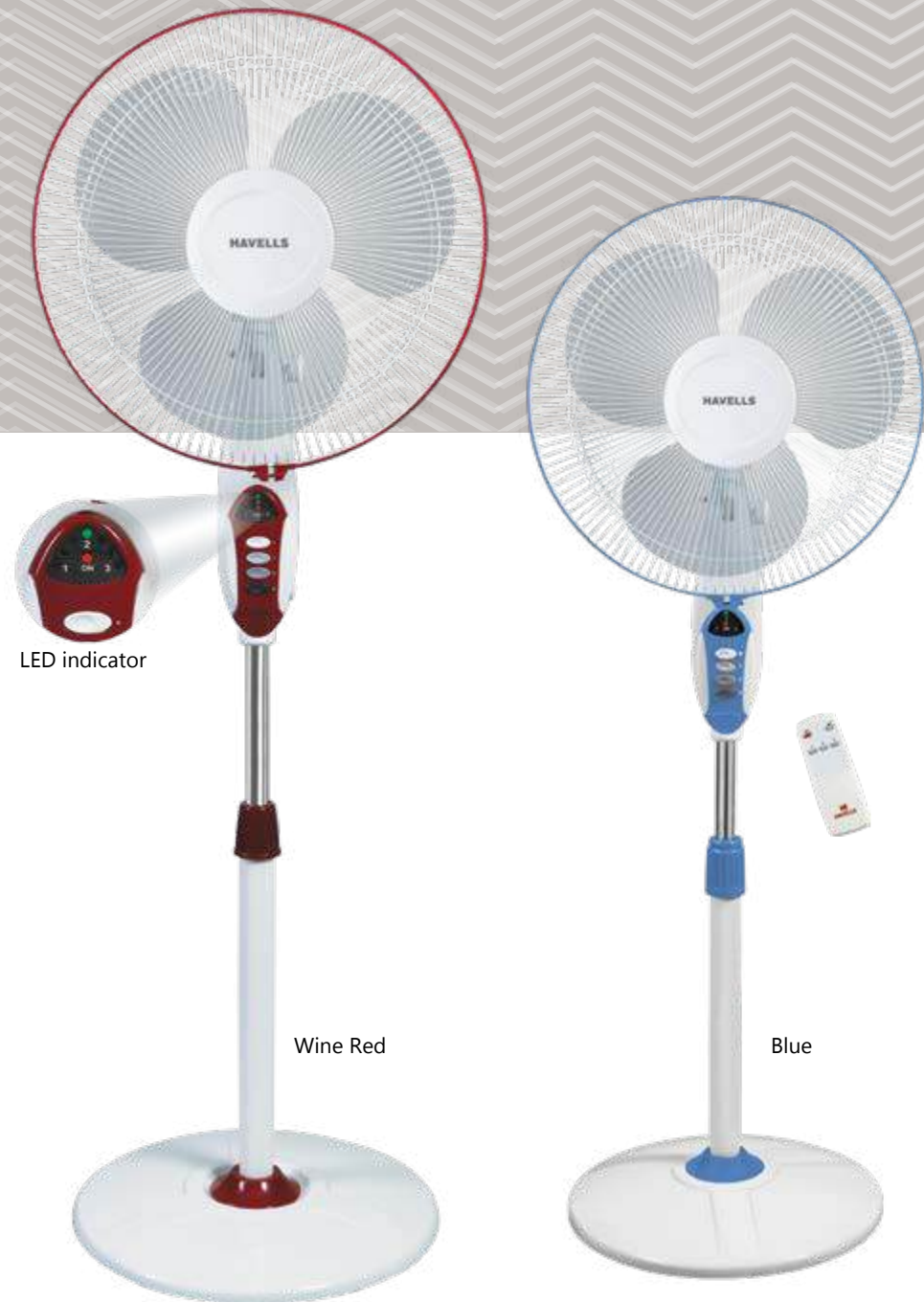

LED indicator

Wine Red

Blue



TRENDY METALLIC

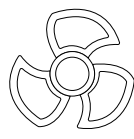

Rust Proof
Aluminium
Blades

Metal blades
with ribs

- Sturdy base for more stability
- Wide oscillation
- 3 Speed regulation
- Rust free ribbed aluminium blades
- Upto 2 hours timer with automatic switch off

STAR RATING	SWEEP	POWER INPUT	SPEED	AIR DELIVERY
NA	400 mm	57 W	1350 r/min	70 m ³ /min



Timer Function



Metallic Black

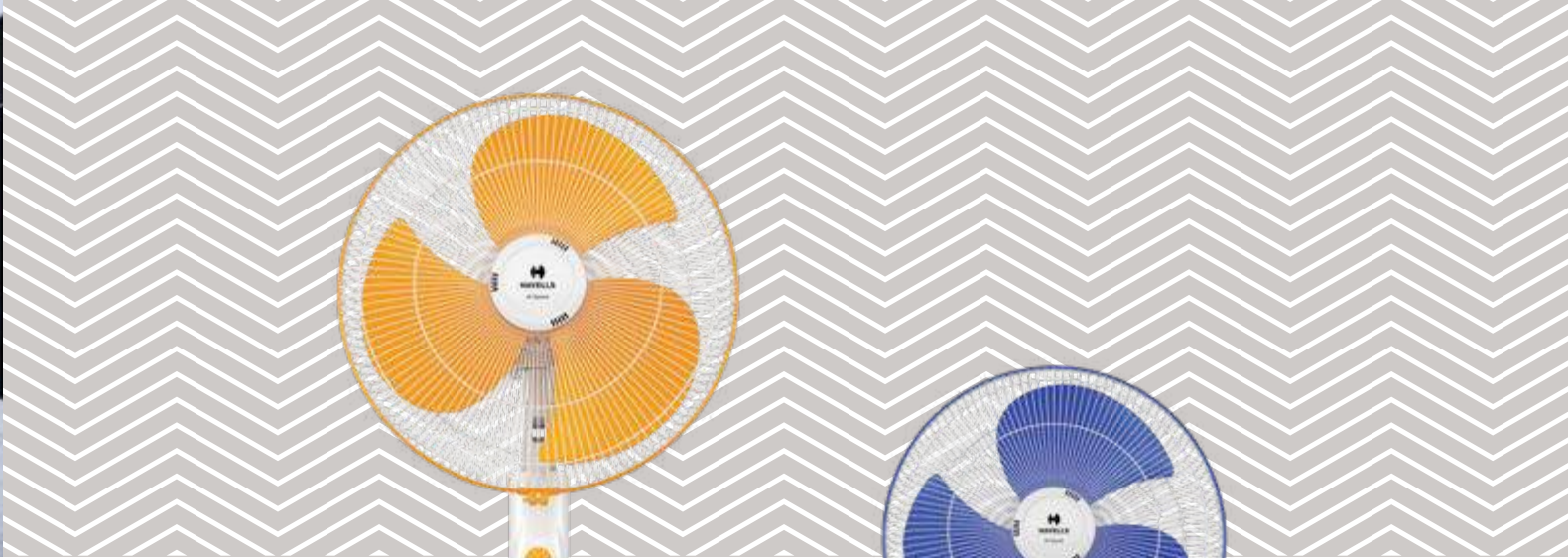

TRENDY HS



Double Ball Bearing

- Motorized smooth oscillation
- 3 Speed control
- Double ball bearing for noiseless operation
- Sturdy base for stability
- ABS blades for better air thrust



Yellow



Blue

STAR RATING	SWEEP	POWER INPUT	SPEED	AIR DELIVERY
NA	400 mm	125 W	2100 r/min	95 m ³ /min





TRENDY



- Elegantly designed switch box
- Higher air delivery
- Sturdy base for stability
- Available in attractive colour combinations

STAR RATING	SWEEP	POWER INPUT	SPEED	AIR DELIVERY
NA	400 mm	57 W	1350 r/min	65 m ³ /min



Blue White



Golden White



Green White



White Grey

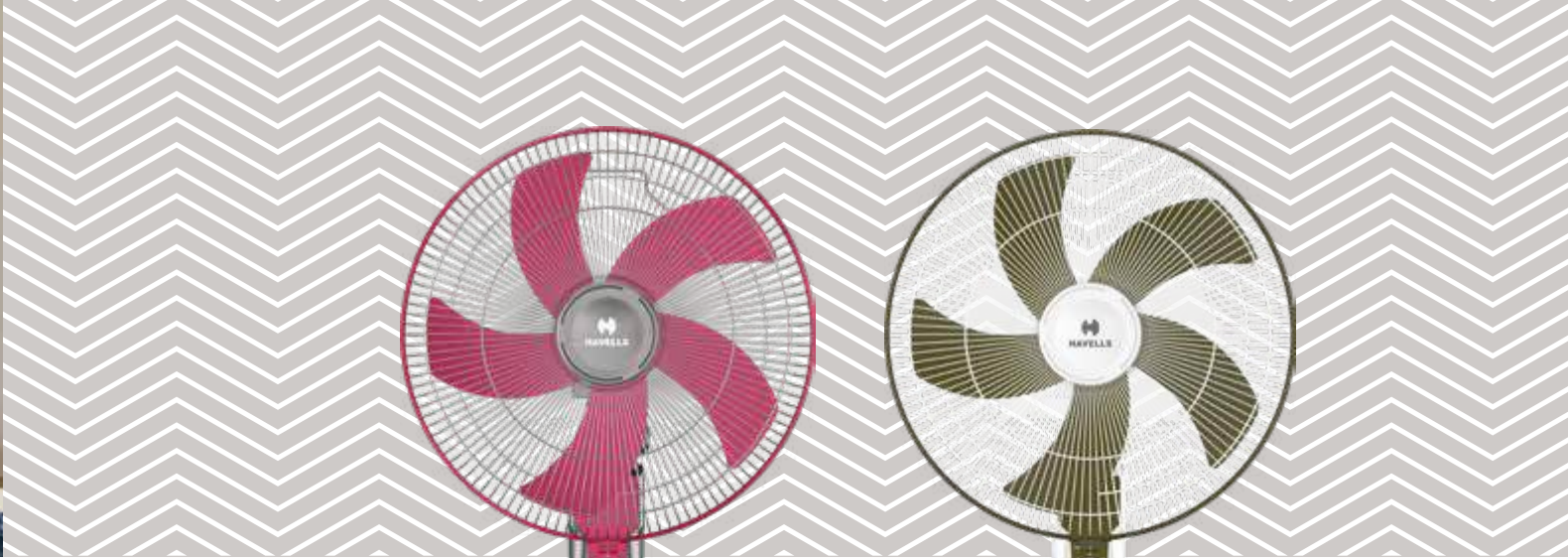

PENTAFORCE



- Elegant Looks
- Sturdy Square Base for more stability
- 3 Speed Control
- 5 Leaf Blade design for High Air delivery
- Upto 2 hours timer with automatic switch off

STAR RATING	SWEEP	POWER INPUT	SPEED	AIR DELIVERY
NA	400 mm	65 W	1350 r/min	70 m ³ /min



Magenta



White Green



MARVELWIND HS



Double Ball Bearing

- Elegant looks
- Double ball bearing for noiseless operation
- Smooth oscillation
- Sturdy base for more stability

STAR RATING	SWEEP	POWER INPUT	SPEED	AIR DELIVERY
NA	400 mm	125 W	2100 r/min	95 m ³ /min



White Blue



White Yellow



SWING HS



Black



White



Double Ball Bearing

- High Speed Fan with powerful motor
- Sturdy base for stability
- Smooth oscillation
- Elegantly designed switch box

STAR RATING	SWEEP	POWER INPUT	SPEED	AIR DELIVERY
NA	400 mm	125 W	2100 r/min	95 cm





ORO



White Red



- 3 speed control
- Smooth oscillation
- Sturdy base for stability
- Translucent blades for aesthetics

STAR RATING	SWEEP	POWER INPUT	SPEED	AIR DELIVERY
NA	400 mm	57 W	1350 r/min	65 m ³ /min

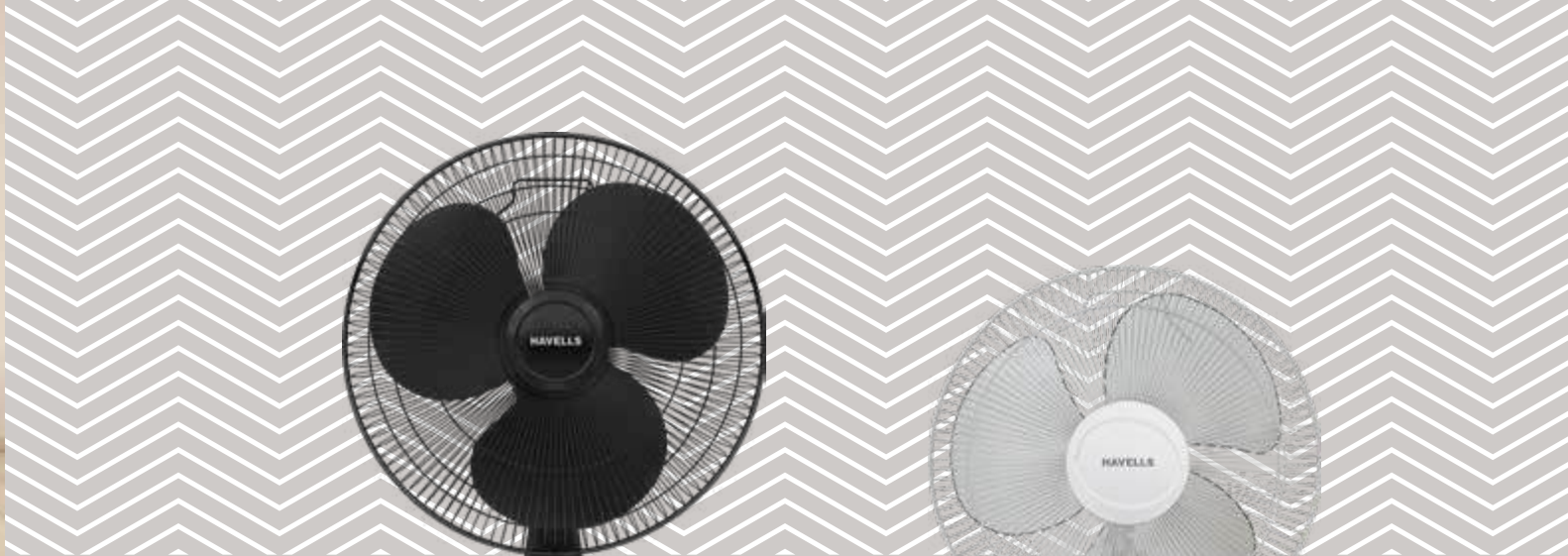

Black



Off White

SWING



- Smooth oscillation
- Sturdy base for stability
- Elegantly designed switch box

STAR RATING	SWEEP	POWER INPUT	SPEED	AIR DELIVERY
	400 mm	57 W	1350 r/min	65 m ³ /min





V2 NEO

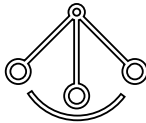

Rust Proof
Aluminium
Blades

Motorized
oscillation

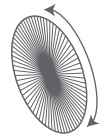

Swing
Feature

Wide Tilt
Angle

- High structural stability
- Sturdy base for stability
- Strong motor for High Air Delivery
- Superior performance even at Low voltage
- Aerodynamically designed rust proof aluminium blades
- Speed independent smooth & constant oscillations

STAR RATING	SWEEP	POWER INPUT	SPEED	AIR DELIVERY
NA	450 mm	95 W	1380 r/min	110 m ³ /min



Black Chrome

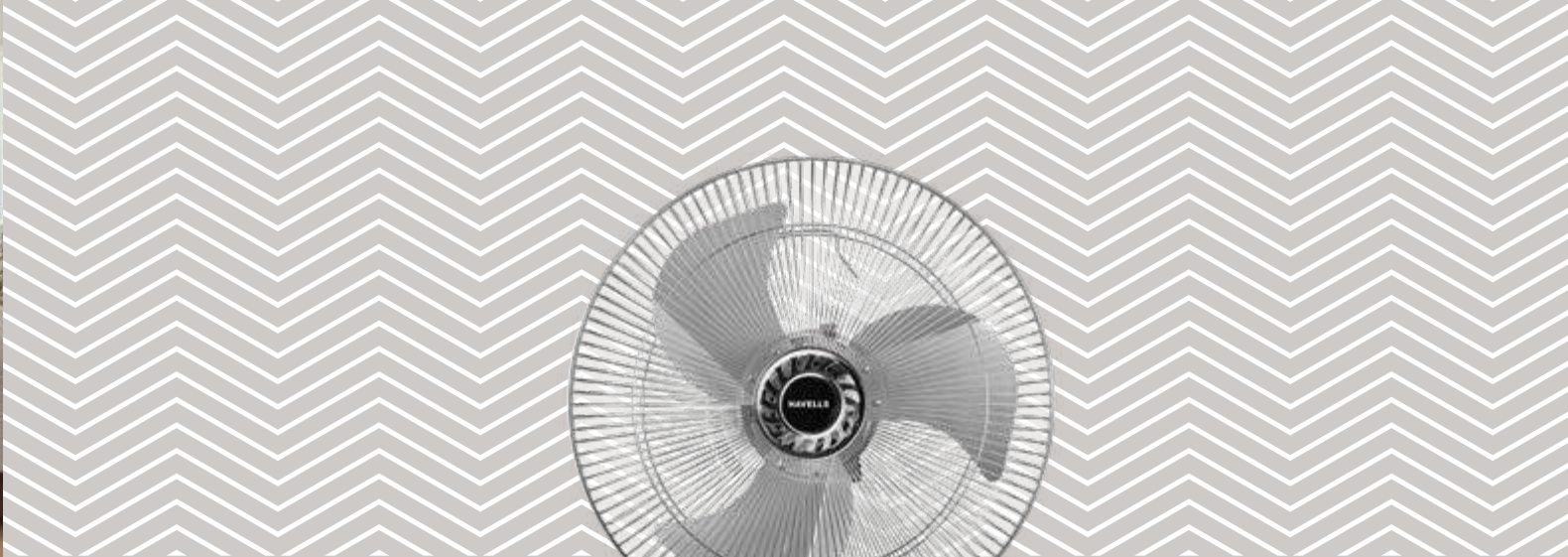

V3



Rust Proof
Aluminium
Blades

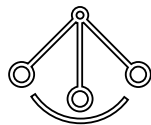

Motorized
oscillation

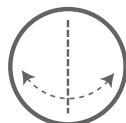

Swing
Feature

- Smooth oscillation
- Aerodynamically designed rust proof aluminium blades
- Sturdy base for stability
- Strong motor for high air delivery



Black Chrome

STAR RATING	SWEEP	POWER INPUT	SPEED	AIR DELIVERY
NA	450 mm	100 W	1400 r/min	110 m ³ /min



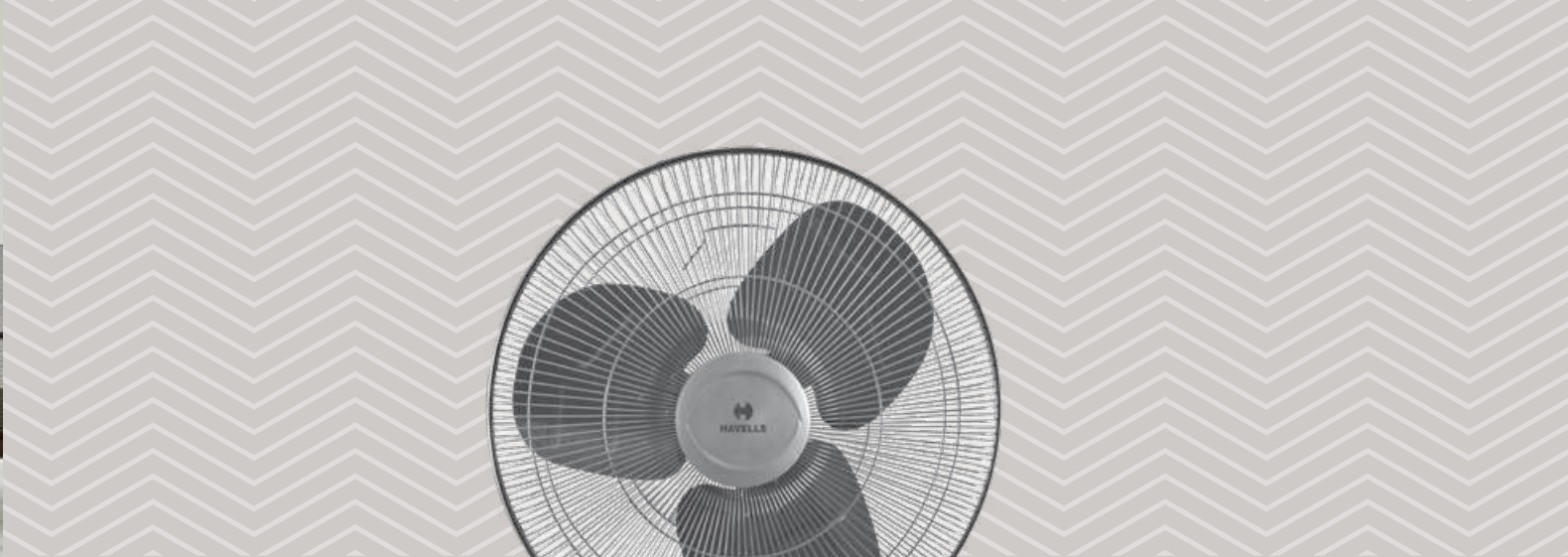

WINDSTORM PRO OXY



High Air
Delivery

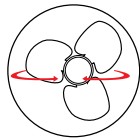

Smooth
Oscillation

- Three speed control
- Attractive bi-colour metallic finish
- Powerful energy efficient heavy duty motor
- Telescopic height adjustment
- All metal body and blade
- Sturdy base for stability
- Smooth oscillation

STAR RATING	SWEEP	POWER INPUT	SPEED	AIR DELIVERY
NA	500 mm	130 W	1400 r/min	140 m ³ /min



Grey



WINDSTORM OXY

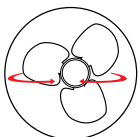

Smooth Oscillation

High Air Delivery

- 3 Speed control
- High performance motor
- Aerodynamically designed blades
- Smooth oscillation
- Sturdy base for stability
- Telescopic height adjustment

Silver Grey



STAR RATING	SWEEP	POWER INPUT	SPEED	AIR DELIVERY
NA	400 mm	115 W	2200 r/min	100 m ³ /min





WINDSTORM PRO



High Air
Delivery

- Three speed control
- Attractive bi-colour metallic finish
- Powerful energy efficient heavy duty motor
- Telescopic height adjustment
- All metal body and blades for stability and durability
- Unique aerodynamically designed 3 leaf metal blade for excellent air thrust

STAR RATING	SWEEP	POWER INPUT	SPEED	AIR DELIVERY
NA	500 mm	130 W	1400 r/min	140 m ³ /min



Grey

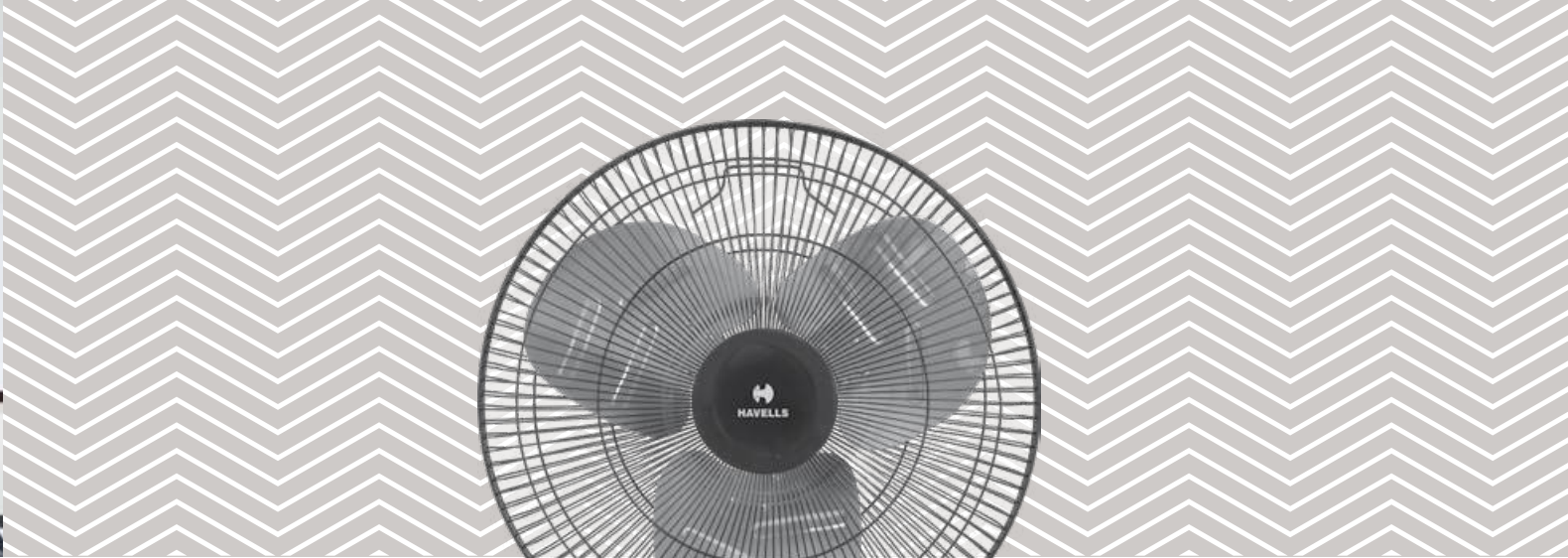

WINDSTORM THUNDER



High Air Delivery

- Three speed control
- Attractive bi-colour metallic finish
- Powerful energy efficient heavy-duty motor
- Telescopic height adjustment
- All metal body and blades for stability and durability
- Unique aerodynamically designed metal blade for maximum air thrust

Black Chrome

STAR RATING	SWEEP	POWER INPUT	SPEED	AIR DELIVERY
NA	500 mm	130 W	1400 r/min	140 m ³ /min





HAVELLS



VENTILAIR
FANS





VENTO JET AUTO

INOX STEEL



Double Ball Bearing



- Brushed steel finish
- Automatic front shutter
- High suction capacity
- Silent operation
- Wall, ceiling and glass mounting
- Modular concept
- ABS body
- Removable screwless front for easy cleaning

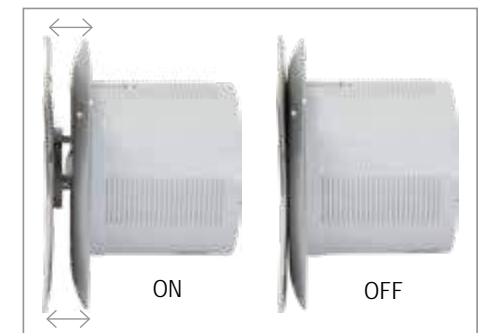
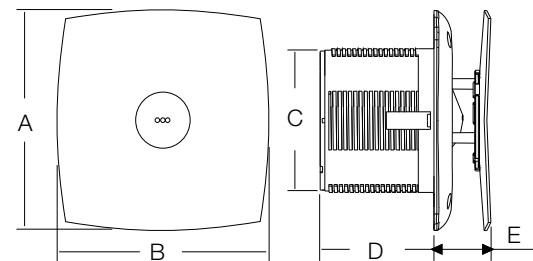

SWEEP	A	B	C	D	E
100 mm	150 mm	150 mm	98 mm	89.5 mm	31 mm
150 mm	194 mm	194 mm	148 mm	124 mm	38 mm

SWEEP	POWER INPUT	SPEED	AIR DELIVERY	RATED VOLTAGE	RATED FREQUENCY	NOISE LEVEL
100 mm	15 W	2500 r/min	98 m ³ /h	230 V	50 Hz	38 dB
150 mm	25 W	2200 r/min	320 m ³ /h	230 V	50 Hz	42 dB



VENTO JET AUTO



Double Ball Bearing



- Off-white color
- Automatic front shutter
- High suction capacity
- Silent operation
- Wall, ceiling and glass mounting
- Modular concept
- ABS body
- Removable screwless front for easy cleaning

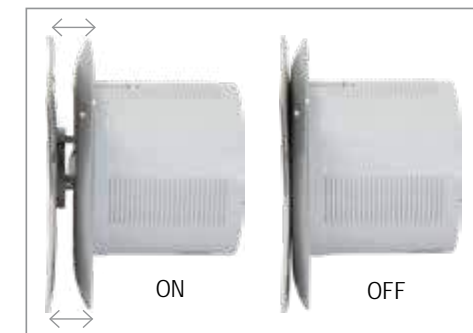
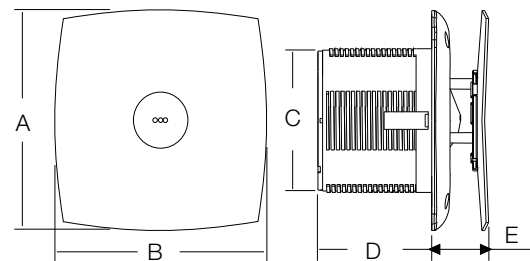

SWEEP	A	B	C	D	E
100 mm	150 mm	150 mm	98 mm	89.5 mm	31 mm
150 mm	194 mm	194 mm	148 mm	124 mm	38 mm

SWEEP	POWER INPUT	SPEED	AIR DELIVERY	RATED VOLTAGE	RATED FREQUENCY	NOISE LEVEL
100 mm	15 W	2500 r/min	98 m ³ /h	230 V	50 Hz	38 dB
150 mm	25 W	2200 r/min	320 m ³ /h	230 V	50 Hz	42 dB



VENTO JET

INOX STEEL



Double Ball Bearing



- Brushed steel finish
- Modular concept
- High suction capacity
- Silent operation
- ABS body
- Wall, ceiling and glass mounting
- Removable screwless front for easy cleaning

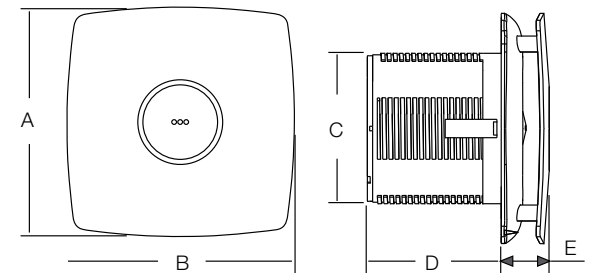

SWEEP	A	B	C	D	E
100 mm	150 mm	150 mm	98 mm	89.5 mm	38 mm
150 mm	194 mm	194 mm	148 mm	124 mm	34 mm

SWEEP	POWER INPUT	SPEED	AIR DELIVERY	RATED VOLTAGE	RATED FREQUENCY	NOISE LEVEL
100 mm	15 W	2500 r/min	98 m ³ /h	230 V	50 Hz	38 dB
150 mm	25 W	2200 r/min	320 m ³ /h	230 V	50 Hz	42 dB



VENTO JET



Double Ball Bearing



THERMAL OVERLOAD PROTECTED MOTORS



100% COPPER WIRE WINDING MOTOR



- Off-white color
- Modular concept
- High suction capacity
- Silent operation
- Wall, ceiling and glass mounting
- ABS body
- Removable screwless front for easy cleaning

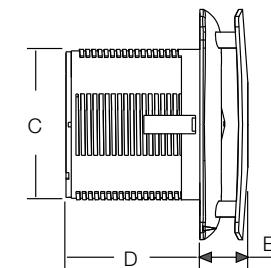
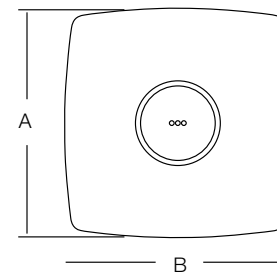

SWEEP	A	B	C	D	E
100 mm	150 mm	150 mm	98 mm	98.5 mm	38 mm
150 mm	194 mm	194 mm	148 mm	124 mm	34 mm

SWEEP	POWER INPUT	SPEED	AIR DELIVERY	RATED VOLTAGE	RATED FREQUENCY	NOISE LEVEL
100 mm	15 W	2500 r/min	98 m ³ /h	230 V	50 Hz	38 dB
150 mm	25 W	2200 r/min	320 m ³ /h	230 V	50 Hz	42 dB



VENTILAIR LX



- Premium design, elegant looks
- Ideal for mounting on glass window and wooden panels
- Protective front frame
- ABS body
- Back side ring for tight fitting
- Auto back shutter for protection against dust and insects
- Removable screwless front for easy cleaning

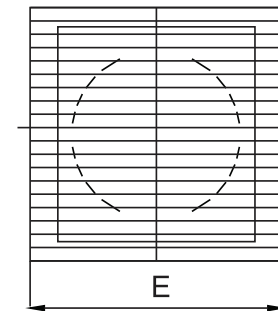
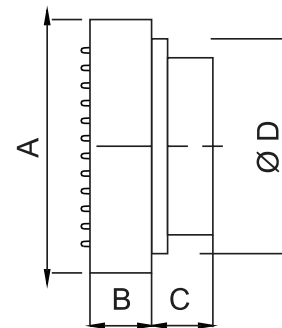

SWEEP	A	B	C	D	E
200 mm	255 mm	22 mm	90 mm	200 mm	255 mm
150 mm	208 mm	21 mm	90 mm	150 mm	208 mm

SWEEP	POWER INPUT	SPEED	AIR DELIVERY	RATED VOLTAGE	RATED FREQUENCY	NOISE LEVEL
200 mm	35 W	1800 r/min	690 m ³ /h	230 V	50 Hz	50 dB
150 mm	22 W	2000 r/min	275 m ³ /h	230 V	50 Hz	50 dB



VENTIL AIR LX-WS



Front Shutter to prevent insect entry



- Modern design, fashionable and elegant looks
- Ideal for mounting on glass window and wooden panels
- Front shutter to protect insects and dust entry
- ABS body
- Removable screwless front for easy cleaning

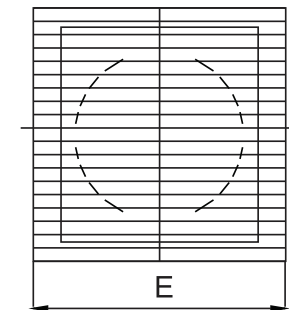
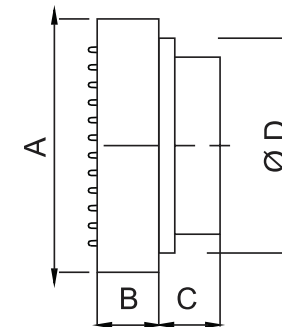

SWEEP	POWER INPUT	SPEED	AIR DELIVERY	RATED VOLTAGE	RATED FREQUENCY	NOISE LEVEL
150 mm	22 W	2000 r/min	275 m ³ /h	230 V	50 Hz	50 dB

SWEEP	A	B	C	D	E
150 mm	208 mm	21 mm	90 mm	150 mm	208 mm



VENTILAIR ZX



- Ease of cleaning & maintenance with removable screwless front
- Seamless design & finish with full flat concealed frame
- Low noise operation
- High Air Delivery
- Ideal for mounting on glass window & wooden panels
- ABS body

SWEEP	A	B	C	D	E
150 mm	194 mm	194 mm	28 mm	124 mm	145 mm

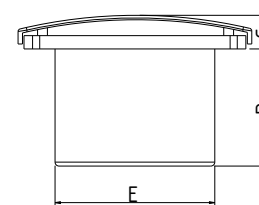
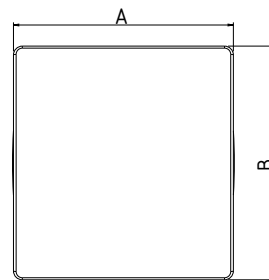

Front View

SWEEP	POWER INPUT	SPEED	AIR DELIVERY	RATED VOLTAGE	RATED FREQUENCY	NOISE LEVEL
150 mm	25 W	2000 r/min	275 m ³ /h	230 V	50 Hz	42 dB



VENTILAIR ZXC



- Ease of cleaning & maintenance
- Seamless design & finish
- Low noise operation
- High Air Delivery
- False ceiling mounting
- Ideal for centrally air conditioned rooms

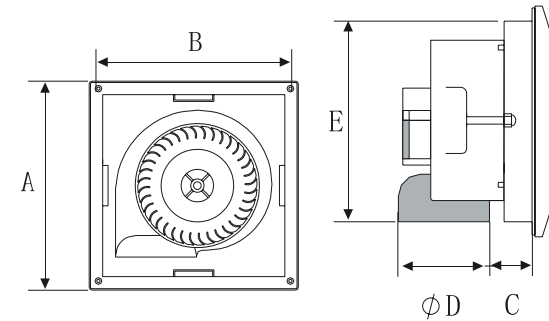

SWEEP	A	B	C	D	E
100 mm	235 mm	213 mm	30 mm	95 mm	200 mm

SWEEP	POWER INPUT	SPEED	AIR DELIVERY	RATED VOLTAGE	RATED FREQUENCY	NOISE LEVEL
100 mm	26 W	1400 r/min	74 m ³ /h	230 V	50 Hz	45 dB





VENTILAIR DXZ NEO

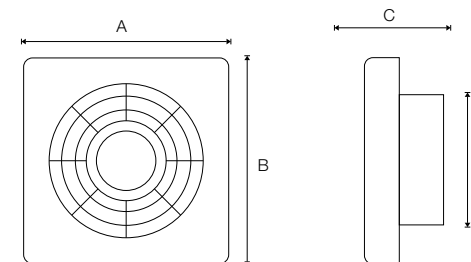

- Easy installation on glass / window panels
- High quality plastic, resistant to colour change
- Elegant front protective grill

SWEEP	A	B	C	D
150 mm	178 mm	178 mm	106 mm	150 mm
100 mm	150 mm	150 mm	108 mm	108 mm

SWEEP	POWER INPUT	SPEED	AIR DELIVERY	RATED VOLTAGE	RATED FREQUENCY	NOISE LEVEL
150 mm	20 W	2100 r/min	250 m ³ /h	230 V	50 Hz	45 dB
100 mm	15 W	2400 r/min	120 m ³ /h	230 V	50 Hz	45 dB



VENTIL AIR ZXR



- Back shutter & fan “ON-OFF” operations are inter-locked through pull cord
- Easy installation on glass & wood panels
- Back shutter for insect protection

SWEEP	POWER INPUT	SPEED	AIR DELIVERY	RATED VOLTAGE	RATED FREQUENCY	NOISE LEVEL
150 mm	26 W	1800 r/min	400 m ³ /h	230 V	50 Hz	45 dB

Sweep	A	B	C	D	E	F	G	H
150 mm	210 mm	150 mm	80 mm	72 mm	35 mm	32 mm	180 mm	142 mm

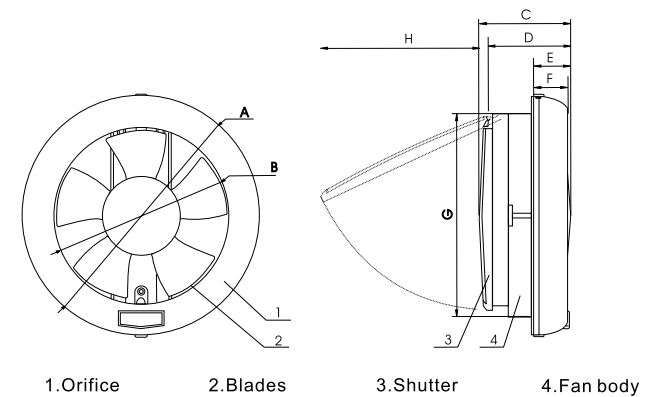



VENTIL AIR HUSH



- Modular concept
- High suction capacity
- Noiseless operation
- Removable front plate for easy cleaning
- Concealed front frame
- Ideal for mounting on glass window & wooden panels
- ABS body



Ivory



Stainless Steel



American Walnut

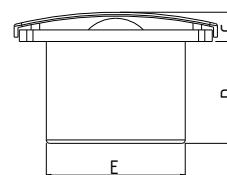
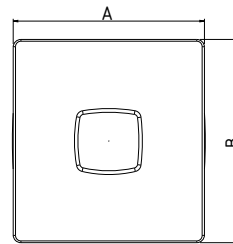

SWEEP	A	B	C	D	E
150 mm	200 mm	200 mm	28 mm	94 mm	145 mm
100 mm	150 mm	150 mm	27 mm	72 mm	98 mm

SWEEP	POWER INPUT	SPEED	AIR DELIVERY	RATED VOLTAGE	RATED FREQUENCY	NOISE LEVEL
150 mm	25 W	2000 r/min	275 m ³ /h	230 V	50 Hz	40 dB
100 mm	15 W	2450 r/min	140 m ³ /h	230 V	50 Hz	35 dB



DXW CELSO



- Modern looks and sleek design for easy fitting
- Ideal for mounting on glass window & wooden panels
- Pull cord for fan switch on-off and shutter open-close
- Shutter to prevent entry of insects, pest and rodents
- Translucent blade
- ABS body

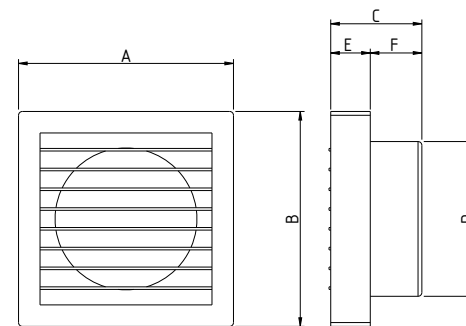

SWEEP	A	B	C	D	E	F
150 mm	198 mm	198 mm	90 mm	148 mm	35 mm	55 mm
200 mm	250 mm	250 mm	250 mm	106 mm	180 mm	60 mm

SWEEP	POWER INPUT	SPEED	AIR DELIVERY	RATED VOLTAGE	RATED FREQUENCY	NOISE LEVEL
150 mm	15 W	1750 r/min	170 m ³ /h	230 V	50 Hz	48 dB
200 mm	20 W	1600 r/min	280 m ³ /h	230 V	50 Hz	48 dB



VENTILAIR BLDC



**BLDC INVERTER
TECHNOLOGY**

- Easy installation on glass window & wood panels
- Powerful air suction for clean and odorless air
- Mosquito net to avoid entry of insects
- Very low noise

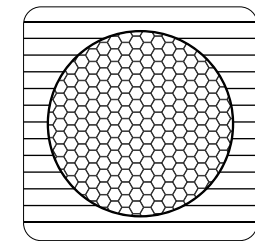
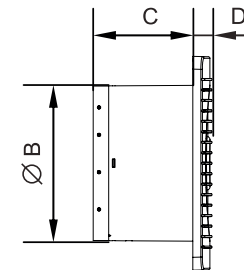
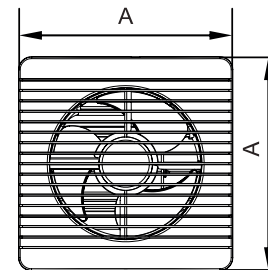

Mosquito Protection Net

SWEEP	A	B	C	D	CUT OUT SPACE FOR INSTALLATION Ø A
200 mm	250 mm	180 mm	128 mm	11 mm	184 mm
150 mm	200 mm	147 mm	93.5 mm	18 mm	153 mm

SWEEP	POWER INPUT	SPEED	AIR DELIVERY	RATED VOLTAGE	RATED FREQUENCY	NOISE LEVEL
200 mm	6 W	1750 r/min	360 m ³ /h	230 V	50 Hz	45 dB
150 mm	5 W	1800 r/min	192 m ³ /h	230 V	50 Hz	45 dB



VENTILAIR DX



- Ideal for mounting on wood
- High quality engineering plastic, resistant to colour change
- Auto Back Shutter for protection from dust, insects & birds
- Detachable oil tray for easy cleaning

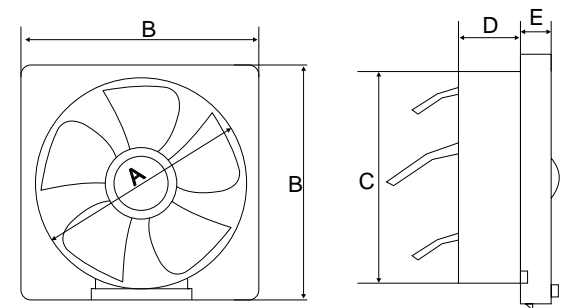

SWEEP	A	B	C	D	E
150 mm	150 mm	241 mm	172 mm	73 mm	50 mm
200 mm	200 mm	298 mm	240 mm	90 mm	40 mm
250 mm	250 mm	348 mm	290 mm	90 mm	48 mm

SWEEP	POWER INPUT	SPEED	AIR DELIVERY	RATED VOLTAGE	RATED FREQUENCY	NOISE LEVEL
150 mm	25 W	1350 r/min	280 m ³ /h	230 V	50 Hz	40 dB
200 mm	32 W	1350 r/min	520 m ³ /h	230 V	50 Hz	45 dB
250 mm	35 W	1200 r/min	860 m ³ /h	230 V	50 Hz	48 dB



THRILL AIR DX



- Automatic back shutter for protection from dust, insects & birds
- Durable motor
- Rust proof body & blades

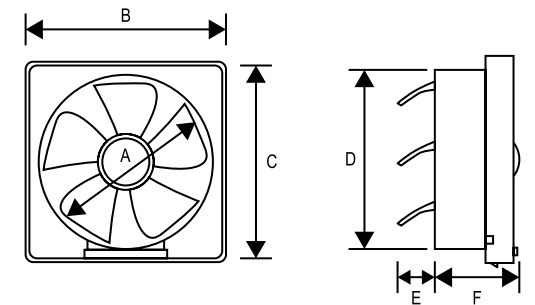

SWEEP	A	B	C	D	E	F
250 mm	250 mm	344 mm	312 mm	291 mm	69 mm	115 mm
200 mm	200 mm	294 mm	262 mm	241 mm	70 mm	101 mm
150 mm	150 mm	244 mm	212 mm	191 mm	65 mm	125 mm

SWEEP	POWER INPUT	SPEED	AIR DELIVERY	RATED VOLTAGE	RATED FREQUENCY	NOISE LEVEL
250 mm	36 W	1300 r/min	900 m ³ /h	230 V	50 Hz	48 dB
200 mm	28 W	1250 r/min	600 m ³ /h	230 V	50 Hz	45 dB
150 mm	22 W	1350 r/min	300 m ³ /h	230 V	50 Hz	40 dB



VENTIL AIR DX HS



- Ideal for mounting on wood
- High quality engineering plastic, resistant to colour change

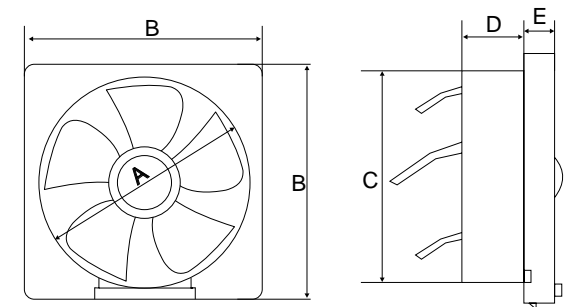

SWEEP	A	B	C	D	E
150 mm	150 mm	241 mm	172 mm	73 mm	50 mm
200 mm	200 mm	298 mm	240 mm	90 mm	40 mm

SWEEP	POWER INPUT	SPEED	AIR DELIVERY	RATED VOLTAGE	RATED FREQUENCY	NOISE LEVEL
150 mm	30 W	2300 r/min	600 m ³ /h	230 V	50 Hz	60 dB
200 mm	65 W	2000 r/min	850 m ³ /h	230 V	50 Hz	60 dB



SMART VENTIL AIR

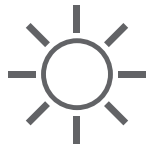
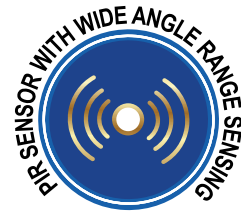

LED indication for auto mode



- PIR based automatic sensor for ON / OFF operation by detecting human presence
- Wide angle range sensing for smooth operation
- LED indication for auto mode. Option to switch to manual mode as well
- Auto back shutter for protection from dust, insects & birds

SWEEP	POWER INPUT	SPEED	AIR DELIVERY
200 mm	32 W	1350 r/min	486 m ³ /h
250 mm	35 W	1200 r/min	720 m ³ /h

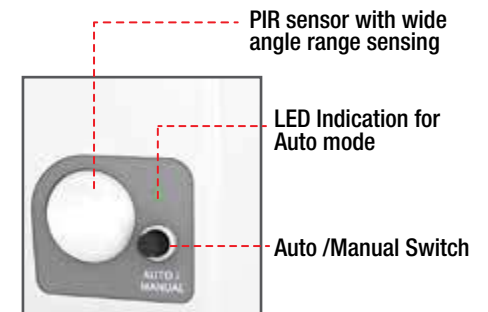



VENTILAIR DB

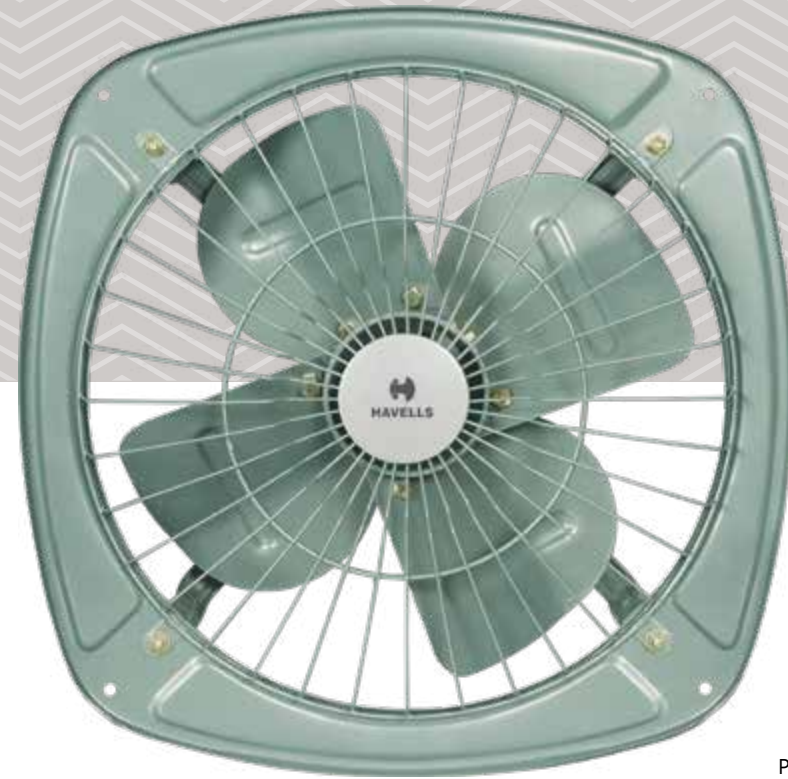

Pista Green

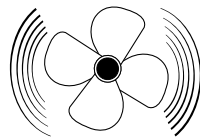

High air delivery

- Double ball bearings
- Heavy duty motor for high air delivery
- Protective steel bird guard
- Robust construction with strong metal body

SWEEP	POWER INPUT	SPEED	AIR DELIVERY	RATED VOLTAGE	RATED FREQUENCY	NOISE LEVEL
300 mm	70 W	1400 r/min	1850 m ³ /h	230 V	50 Hz	45 - 50 dB
230 mm	40 W	1400 r/min	860 m ³ /h	230 V	50 Hz	45 - 50 dB



Choco Brown



Pista Green

VENTILAIR DSP



- Easy Clean technology for dust & grease removal
- Specially designed metal blade with lacquer
- Powder coated long lasting finish
- Sturdy steel bird guard with rust free feature
- Strong metal body

SWEEP	POWER INPUT	SPEED	AIR DELIVERY	RATED VOLTAGE	RATED FREQUENCY	NOISE LEVEL
150 mm	30 W	1400 r/min	275 m ³ /h	230 V	50 Hz	45-50 dB
230 mm	40 W	1350 r/min	600 m ³ /h	230 V	50 Hz	45-50 dB
300 mm	50 W	1350 r/min	900 m ³ /h	230 V	50 Hz	45-50 dB

Note: Pista Green is available without easy clean technology



VENTILAIR DS HS

REVERSIBLE



- Reversible blade movement for fresh air intake
- Specially designed metal blades
- Powder coated for long lasting finish
- Sturdy steel bird guard

SWEEP	POWER INPUT	SPEED	AIR DELIVERY	RATED VOLTAGE	RATED FREQUENCY	NOISE LEVEL
230 mm	65W	2300 r/min	1050 m ³ h	230 V	50 Hz	68 dB
300 mm	75 W	2300 r/min	1533 m ³ h	230 V	50 Hz	70 dB



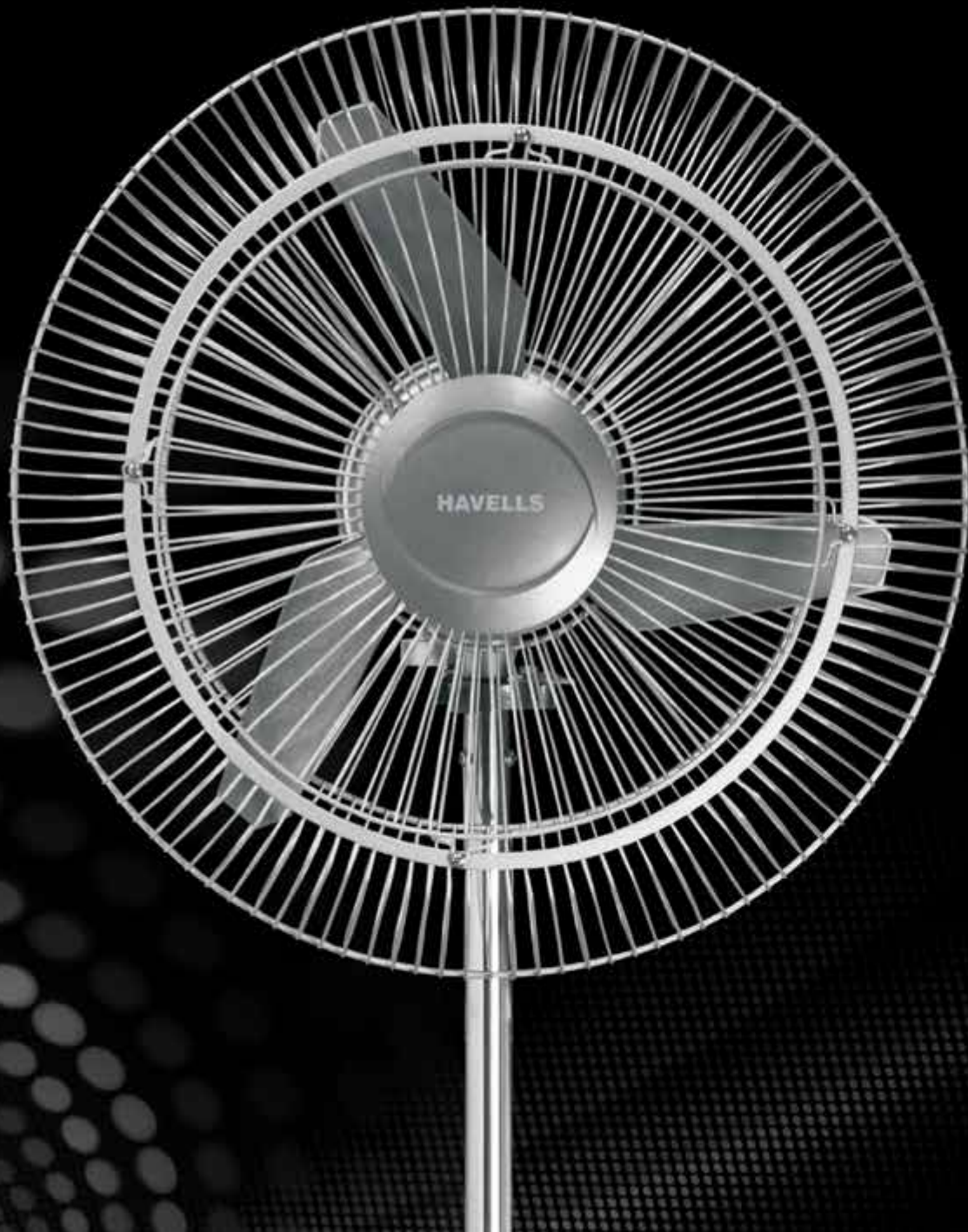

INDUSTRIAL FANS





TURBOFORCE

PEDESTAL AIR CIRCULATOR FAN



Double Ball Bearing



THERMAL OVERLOAD PROTECTED MOTORS



100% COPPER WIRE WINDING MOTOR

- Aerodynamically designed blades for higher air delivery and minimal noise levels
- Double 'Z' shielded ball bearings for longer life
- Oscillation up to 90° for total flexibility
- Sturdy brazed wire guards with powder coating ensures corrosion resistance
- Generally conforming to IS: 2997-1964 standards
- Available in 450 mm, 600 mm and 750 mm sweep

DIMENSIONAL SPECIFICATIONS

SWEEP	A	B	C	D	E	F	
						MINIMUM	MAXIMUM
450 mm	500 mm	145 mm	365 mm	785 mm	450 mm	1290 mm	1430 mm
600 mm	670 mm	166 mm	390 mm	1150 mm	585 mm	1340 mm	1650 mm
750 mm	840 mm	176 mm	412 mm	1150 mm	705 mm	1340 mm	1650 mm

TECHNICAL SPECIFICATIONS

SWEEP	RATED VOLTAGE	FREQUENCY	POWER INPUT	SPEED	PHASE	AIR DELIVERY	NO. OF BLADES	NO. OF SPEEDS	NOISE LEVEL
450 mm Pedestal	230 V	50 Hz	100 W	1440 r/min	1 Phase	150 m ³ /min	3 N	3	62 dB
600 mm Pedestal	230 V	50 Hz	180 W	1440 r/min	1 Phase	280 m ³ /min	3 N	1	72 dB
750 mm Pedestal	230 V	50 Hz	235 W	1400 r/min	1 Phase	300 m ³ /min	3 N	1	75 dB

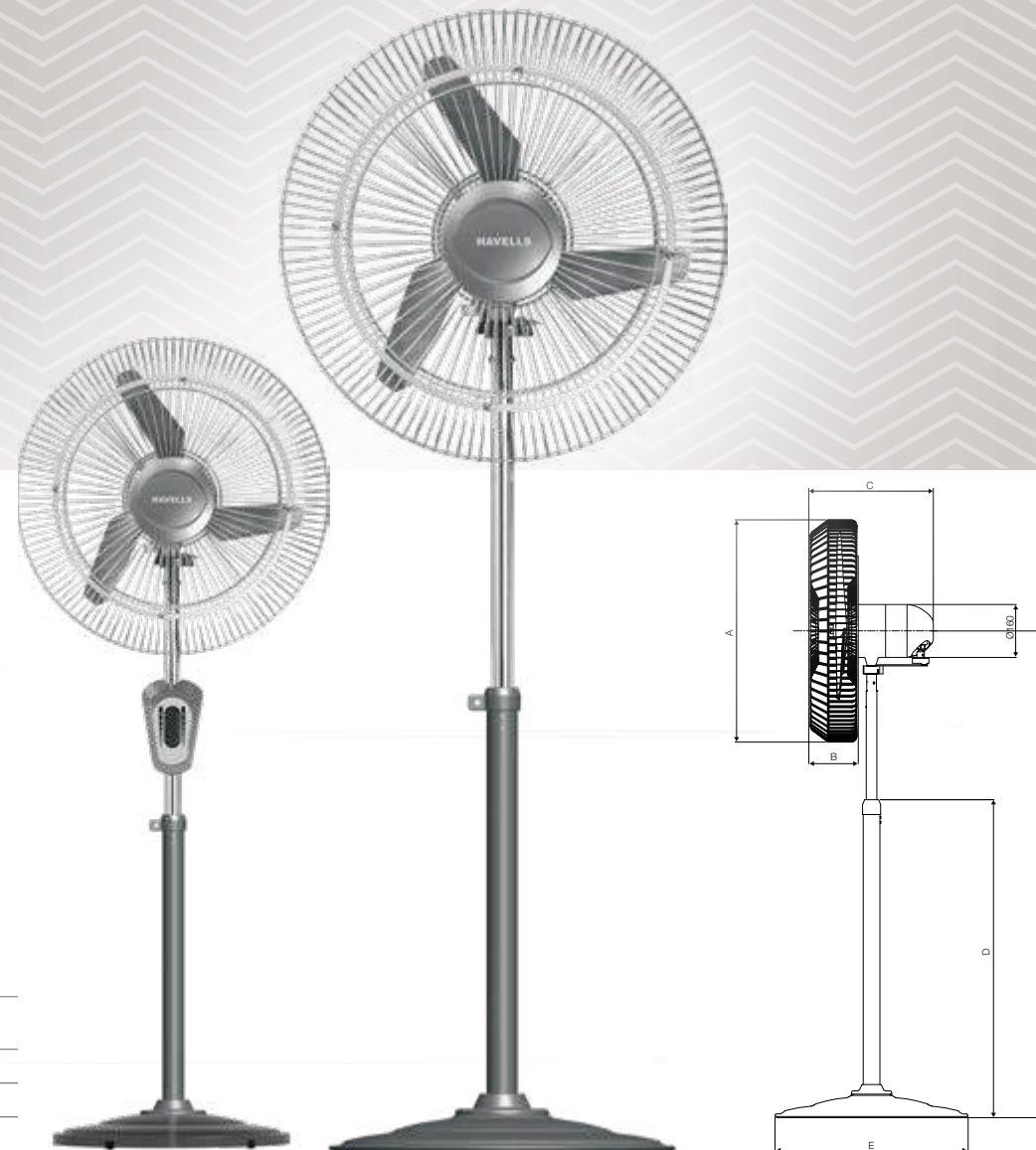

Air delivery measurement at a distance of 6 times blade sweep from the fan.

Built-in regulators available only for 450 mm sweep.

Conforming to IS: 2997-1964.

Tolerance on ratings (As per IS 2997-1964)

Speed -10%

Power +10%

Air Delivery -10%





TURBOFORCE

WALL AIR CIRCULATOR FAN



Double Ball Bearing



- Aerodynamically designed blades for higher air delivery and minimal noise levels
- Double 'Z' shielded ball bearings for longer life
- Indexable to different positions up to 15°
- Oscillation up to 90° for total flexibility
- Sturdy brazed wire guards with powder coating ensures corrosion resistance
- Generally conforming to IS: 2997-1964 standards
- Available in 450 mm, 600 mm and 750 mm sweep

DIMENSIONAL SPECIFICATIONS

SWEEP	A	B	C	D	E	G1	G2	H
450 mm	500 mm	145 mm	590 mm	200 mm	565 mm	84 mm	108 mm	157 mm
600 mm	670 mm	166 mm	585 mm	185 mm	680 mm	150 mm	120 mm	170 mm
750 mm	840 mm	176 mm	660 mm	185 mm	680 mm	150 mm	120 mm	170 mm

TECHNICAL SPECIFICATIONS

SWEEP	RATED VOLTAGE	FREQUENCY	POWER INPUT	SPEED	PHASE	AIR DELIVERY	NO. OF BLADES	NO. OF SPEEDS	NOISE LEVEL
450 mm Wall	230 V	50 Hz	100 W	1440 r/min	1 Phase	150 m ³ /min	3 N	3	62 dB
600 mm Wall	230 V	50 Hz	180 W	1440 r/min	1 Phase	280 m ³ /min	3 N	1	72 dB
750 mm Wall	230 V	50 Hz	235 W	1400 r/min	1 Phase	300 m ³ /min	3 N	1	75 dB

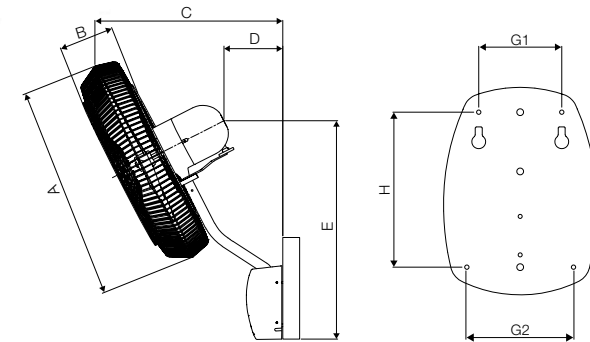

Air delivery measurement at a distance of 6 times blade sweep from the fan.
 Built-in regulators available only for 450 mm sweep.
 Conforming to IS: 2997-1964.

Tolerance on ratings (As per IS 2997-1964)
 Speed -10%
 Power +10%
 Air Delivery -10%





TURBOFORCE / TURBOFORCE NEO

HEAVY DUTY EXHAUST FAN

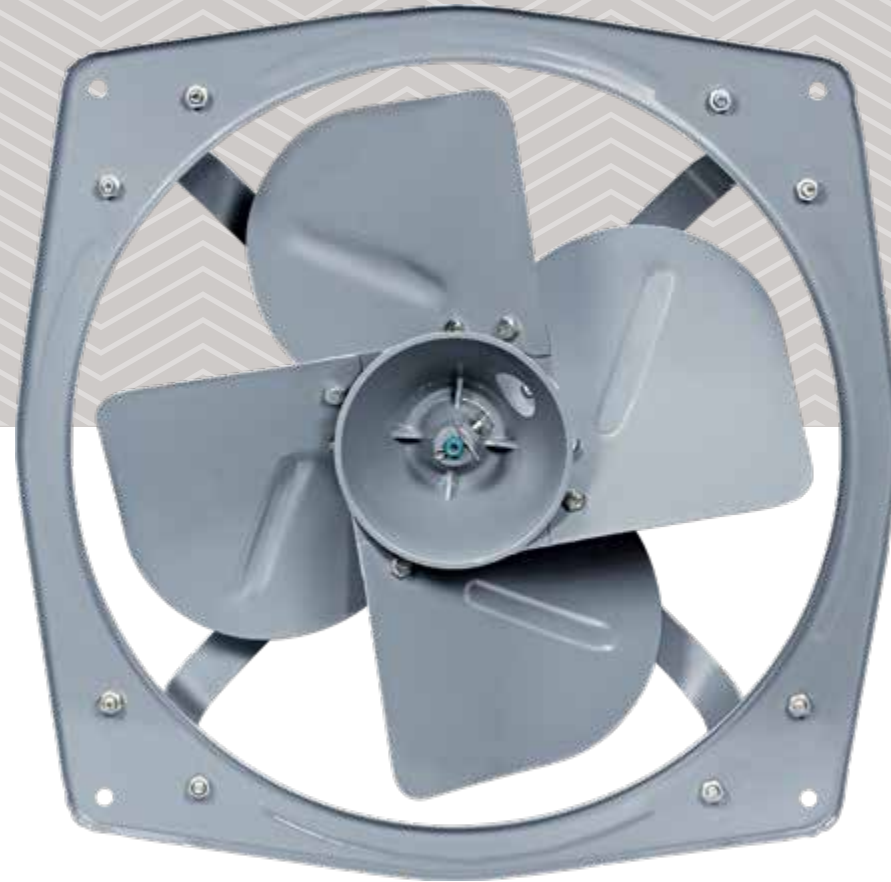

Double Ball
Bearing



- Corrosion resistant body, minimal noise operation & maintenance free design
- Totally enclosed, highly efficient heavy duty motor with pressure die cast aluminium rotor mounted on two ball bearings
- Aerodynamically contoured blades handle maximum air with minimum power consumption
- Rigid frame with rubber mountings for silent operation
- Conforming to IS: 2312 -1967
- Available in various sizes with I & III phase
- An IP55 rated product (protected from limited dust ingress and from low pressure water jets from any direction)
- Available in 300 mm, 380 mm, 450 mm, 600 mm & 900 mm Sweep

NOTE : Above sizes are available in 900 r/min and 1400 r/min



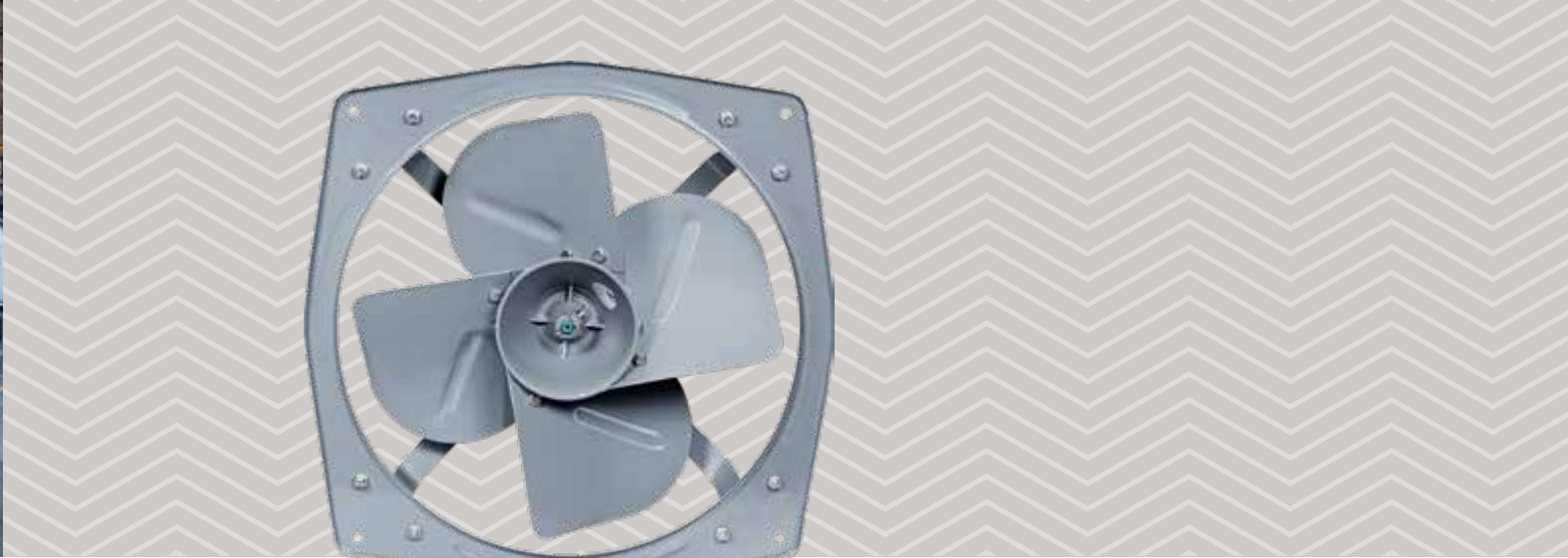

DIMENSIONAL SPECIFICATIONS

SWEEP	Ø H mm	X mm	YSQ mm	Ø S mm
300 mm H.D. Exhaust Fan	7.7 mm	388 mm	310 mm	322 mm
380 mm H.D. Exhaust Fan	10.5 mm	462 mm	373 mm	401 mm
450 mm H.D. Exhaust Fan	10.5 mm	550 mm	442 mm	483 mm
600 mm H.D. Exhaust Fan	10.5 mm	718 mm	603 mm	635 mm

TECHNICAL SPECIFICATIONS

SWEEP	PHASE	SPEED	POWER INPUT	CURRENT	FREE AIR FLOW	NOISE LEVEL
300 mm	1 Phase	900 r/min	55 W	0.26 A	1275 m³/h	50 dB - 55 dB
		1400 r/min	90 W	0.43 A	1950 m³/h	60 dB - 65 dB
380 mm	1 Phase	900 r/min	100 W	0.48 A	2250 m³/h	55 dB - 60 dB
		1400 r/min	166 W	0.77 A	3700 m³/h	65 dB - 70 dB
450 mm	1 Phase	900 r/min	145 W	0.7 A	4400 m³/h	60 dB - 65 dB
		1400 r/min	410 W	1.98 A	6200 m³/h	75 dB - 80 dB
600 mm	1 Phase	900 r/min	850 W	2.65 A	10520 m³/h	70 dB - 75 dB
380 mm	3 Phase	1400 r/min	170 W	0.4 A	3700 m³/h	65 dB - 70 dB
450 mm	3 Phase	1400 r/min	370 W	0.82 A	6800 m³/h	75 dB - 80 dB
600 mm	3 Phase	900 r/min	500 W	0.95 A	10520 m³/h	70 dB - 75 dB
900 mm	3 Phase	700 r/min	1320 W	5.73 A	25200 m³/h	75 dB - 80 dB

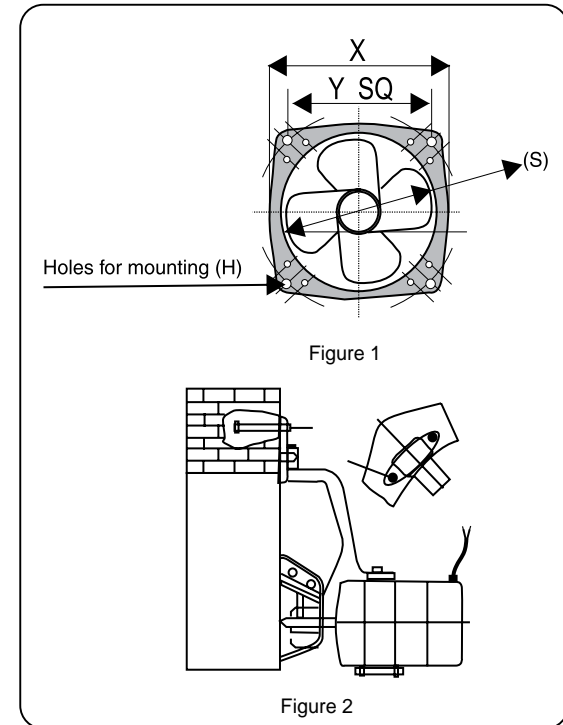

Tolerance on ratings	(As per IS 2312-1967)
Speed	-5% to +10%
Power	+10%
Air Delivery	-10%

At 230 V, 1 Phase, 50 Hz AC
or 400 V, 3 Phase, 50 Hz AC



TURBO FORCE PLUS

HEAVY DUTY EXHAUST FAN



Double Ball Bearing

Wider Blade Tip

- Energy efficient copper wire winding motor
- Totally enclosed, highly- efficient heavy duty motor, rotor
- Aerodynamically balanced impellers & blades for smooth & vibration free operation
- Rigid frame with rubber mounting for silent operation
- Powder coated Grey shade finish

DIMENSIONAL SPECIFICATIONS

SWEEP	Ø H mm	X mm	YSQ mm	Ø S mm
450 mm	10.5 mm	550 mm	442 mm	483 mm

TECHNICAL SPECIFICATIONS

SWEEP	POWER INPUT	SPEED	AIR DELIVERY	CURRENT	PHASE	NOISE LEVEL
450 mm	300 W	1400 r/min	5300 m ³ h	1.4 A	Single	70 dB - 75 dB

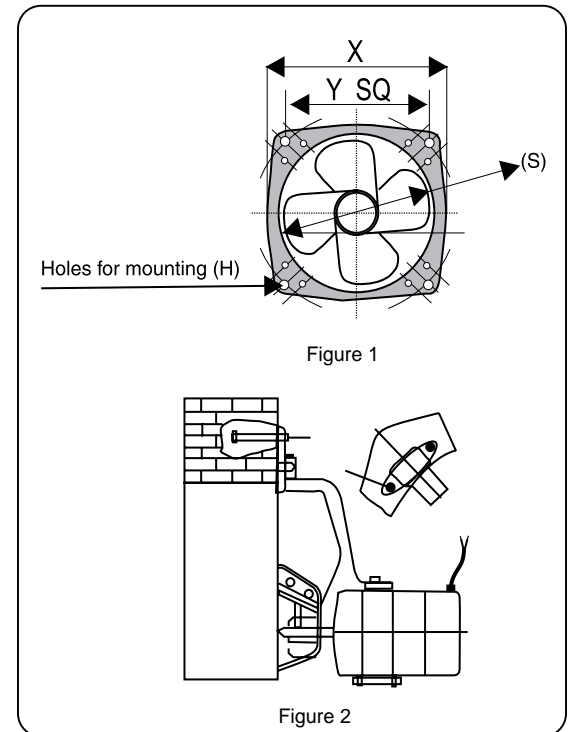

Tolerance on ratings
 Speed -5% to +10%
 Power +10%
 Air Delivery -10%

At 230 V, 1 Phase, 50 Hz AC
 or 400 V, 3 Phase, 50 Hz AC



TURBO FORCE DX

HEAVY DUTY EXHAUST FAN



Double Ball Bearing



Wider Blade Tip



- Corrosion resistant body, minimal noise operation & maintenance free design
- Totally enclosed, highly efficient heavy duty motor with pressure die cast aluminium rotor mounted on two ball bearings
- Aerodynamically contoured blades handle maximum air with minimum power consumption
- Rigid frame with rubber mountings for silent operation
- Conforming to IS: 2312 -1967
- An IP55 rated product (protected from limited dust ingress and from low pressure water jets from any direction)

DIMENSIONAL SPECIFICATIONS

SWEEP	Ø H mm	X mm	YSQ mm	Ø S mm
450 mm	10.5 mm	550 mm	442 mm	483 mm

TECHNICAL SPECIFICATIONS

SWEEP	POWER INPUT	SPEED	AIR DELIVERY	CURRENT	PHASE	NOISE LEVEL
450 mm	385 W	1400 r/min	6200 m ³ h	1.3 A	Single	70 dB - 75 dB

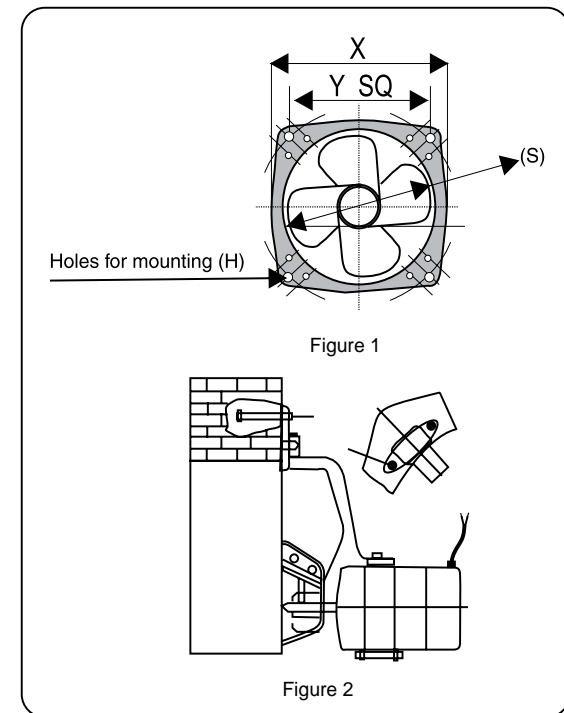

Tolerance on ratings (As per IS 2312-1967)

Speed	-5% to +10%
Power	+10%
Air Delivery	-10%

At 230 V, 1 Phase, 50 Hz AC
or 400 V, 3 Phase, 50 Hz AC

BLDC MODELS REMOTE OPERATION

S. No.	FEATURES	*APP / REMOTE CONTORL (* for IoT models only)	* Momenta UL BLDC (IoT)	Florette UL/ Albus UL Smart Sense BLDC	* Crista BLDC UL (IoT)	* Inox BLDC UL (IoT)	Libeccio UL	* Elio UL BLDC (IoT)	Stealth BLDC Voice	* Stealth Smart BLDC (IoT)	Libeccio BLDC, Florette BLDC, Inox BLDC, Crista BLDC	
1	Signal Type	Remote	RF Pebble	RF Pebble	RF Pebble	RF Pebble	RF Pebble	RF Pebble	RF Pebble	RF Pebble	RF Pebble	
2	ALL ON/OFF	Remote / App	√	√	√	√	√	√	X	X	X	
3	Fan ON/OFF	Remote / App	√	√	√	√	√	√	√	√	√	
4	Speed Control - 1, 2, 3, 4, 5	Remote / App	√	√	√	√	√	√	√	√	√	
5	Smart Sense	Remote	X	√	X	X	X	X	X	X	X	
6	Breeze Mode	Remote / App	√	√	√	√	√	√	√	√	X	
	Mop Mode	Remote / App	√	√	X	X	X	√	√	√	X	
	Sleep Mode	Remote / App	√	√	√	√	√	√	√	√	X	
	Boost Mode	Remote / App	X	X	X	X	X	√	X	X	X	
7	Timer	Remote / App	2 h, 4 h, 6 h, 8 h									
8	Reverse	Remote	X	√	X	X	√	X	X	√	X	
9	Light ON/OFF	Remote / App	√	√	√	√	√	√	X	X	X	
10	Light color changing	Remote / App	Cool, Natural, Warm	Cool, Natural, Warm	Cool, Natural, Warm	Cool, Natural, Warm	Cool, Natural, Warm	Cool, Natural, Warm	X	X	X	
11	Light Intensity	Remote / App	√	√	√	√	√	√	X	X	X	
12	IoT Reset	Remote	√	X	√	√	X	√	X	√	X	
13	Voice control	Voice Module	X	X	X	X	X	X	Manual	X	X	
14	Alexa / Google	App	√	X	√	√	X	√	X	√	X	
15	Grouping	App	√	X	√	√	X	√	X	√	X	
16	Scheduling	App	√	X	√	√	X	√	X	√	X	
17	BLE Local Control	App	√	X	√	√	X	√	X	√	X	
18	Regulator Compatability	-	X	X	X	X	X	X	X	X	X	
19	Heater	Remote	X	X	X	X	X	X	X	X	X	

ALL CEILING FANS ARE WITH DOUBLE BALL BEARING.

RF Remote for all direction sensing



Wi-Fi Reset

Reset

All ON/OFF

Intensity Up/Down



1,2,3,4,5 Fan Speed



Color Mode

Colour

Fan ON/OFF



Preset Timer

Timer

Breeze Mode

It enables to feel refreshing breeze with automatic speed variation



Timer Setting upto 8 hours
2 h, 4 h, 6 h, 8 h

Timer

Mop Mode

It helps to dry wet floor post mopping swiftly



Light ON/OFF

Light

Sleep Mode

It provides ideal sleep by reducing fan speed after specified intervals



Mode Control

Mode

Boost Mode

It provides automatic speed variations after every 25 seconds - 30 seconds



Features may vary from model to model.

HAVELLS INDIA LTD.

Corp Office: QRG Towers, 2D, Sector-126,

Expressway, Noida-201304 (U.P.) Ph. +91-120-4771000

Email : marketing@havells.com, Website : www.havells.com

Customer Care No. 08045 77 1313

CIN: L31900DL1983PLC016304

Pictures and details of the product(s) in this catalogue are merely illustrative. Actual products may vary in colour, design, description and colour combination etc. Due care has been taken that the information provided herein is accurate but is subject to human error.

The information is updated from time to time. Havells India Limited reserves its rights to amend data/details without prior notice.

Copyright Subsists. Imitation of trade dress, graphics and color scheme of this document is a punishable offence.

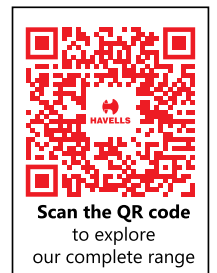

HAVELLS INDIA LTD.

Corp Office: QRG Towers, 2D, Sector-126,
Expressway, Noida-201304 (U.P.) Ph. +91-120-4771000
Email : marketing@havells.com,
Website : www.havells.com Customer Care No. 08045 77 1313

CIN: L31900DL1983PLC016304

Pictures and details of the product(s) in this catalogue are merely illustrative. Actual products may vary in colour, design, description and colour combination etc. Due care has been taken that the information provided herein is accurate but is subject to human error. The information is updated from time to time. Havells India Limited reserves its rights to amend data/details without prior notice.

Copyright Subsists. Imitation of trade dress, graphics and color scheme of this document is a punishable offence.

