



HAVELLS



**Intelligent
heating**

START. SET.
SHOWER.



PURO TURBO DX



INSTANIO



OPAL



ADONIA R



MONZA SLIM



BIANCA

buy online* at **shop.havells.com**

*Online shopping is applicable on select products.

ABOUT US

Havells India Limited is a leading Fast Moving Electrical Goods (FMEG) Company and a major power distribution equipment manufacturer with a strong pan India presence. Havells enjoys enviable market dominance across a wide spectrum of products, including Industrial & Domestic Circuit Protection Devices, Cables & Wires, Motors, Fans, Modular Switches, Home Appliances, Electric Water Heaters, Power Capacitors, CFL, Luminaires for Domestic, Commercial and Industrial Applications.

'Today, Havells owns some of the most prestigious brands like Crabtree and Standard.' Its network constitutes of 4000 professionals, over 6000 dealers and 40 branches across the country. Its eleven state-of-the-art manufacturing plants in India located at Haridwar, Baddi, Sahibabad, Faridabad, Alwar and Neemrana are manufacturing globally acclaimed products, synonymous with excellence and precision in the electrical industry.

The company pioneered the concept of exclusive brand showroom in the electrical industry with 'Havells Galaxy'. Today over 386 Havells Galaxies across the country are helping customers, both domestic and commercial, to choose from a wide variety of products for different applications. Havells became the first FMEG Company to offer door step service via its initiative 'Havells Connect'. Thanks to the quality of products and quicker service, it has minimum customer complaints and highest customer satisfaction.



INDIA'S

most modern and integrated manufacturing plant for Water Heaters:

The Water Heater plant is the crown jewel in our jewellery box. Located in Neemrana, we pride ourselves on having India's most modern and integrated Water Heaters manufacturing plant with a capacity of producing over 5 lakhs Water Heaters annually. Housing a state-of-the-art testing laboratory and also equipped with technology like an automatic MIG welding, dry powder enamel coating, automatic PUF filling and outer body-rolling for metal range. It also has a computerized online safety testing process that makes sure every Havells Water Heater is safe and secure for your use.

Innovation at its best.

Today, Havells Water Heaters meet diverse individual needs across the country. Havells pioneered in introducing state-of-the-art, "Adonia" Water Heater with first ever color changing LED indicating change in temperature. It is all set to become India's revolutionary energy efficient Water Heaters.





SPREAD THE WARMTH OF YOUR LOVE

with Havells Storage & Instantaneous electric Water Heaters



WHY HAVELLS WATER HEATERS?

Water Heaters that understand you.

At Havells we believe in creating technology that makes a difference and our products aim at making your life easier and more comfortable. This philosophy is what makes our products the best-in-class compared to the many others in the market.

You should not be made to choose between convenience and performance. This is why our Water Heaters come equipped with temperature sensitive color changing LED indicators and an 'Incoloy 800' glass coated heating element which ensures superior performance and convenience to you.

These innovative features, which are designed keeping you in mind, ensure that Havells Water Heaters never come up short. Equipped with India's first integrated shock safe plug that cuts power in case of any current leakage along with superior Feroglas technology, that protects the inner tank of your Water Heaters from corrosion and rust. We believe our products are the right choice for all your needs. With National Energy Conservation award - 2019, to its name, along with the needs of the customers, Havells has proved that it cares for the environment too.



Colour changing LED indicator

India's first colour changing LED indicator that changes colour from Blue to Amber as the water heats to the desired temperature.



Feroglas coating inner container

- A) Made of ultra thick super cold rolled steel plates .
- B) Provides superior corrosion resistance and 'anti-rust property' resulting in longer life compared to standard inner container designs.
- C) Tough enough to withstand high pressure rating up to 8 bar.



Shock safe plug (Available in select models)

India's first integrated shock safe plug is designed to prevent injury to humans due to electric shocks, the plug will cut off the power immediately in case of any current leakage.

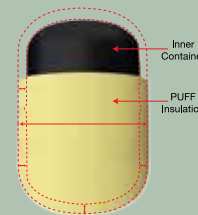

High density PUF insulation

CFC free thicker PUF insulation offers complete protection against radiant heat loss, reduces energy consumption and provides higher energy efficiency.



Incoloy glass coated heating element

Incoloy glass coated heating element offers superior heating performance with its excellent resistance to both oxidation and carbonization at high temperature setting. Also resists corrosion against extreme and hard water conditions thus extending life span of heating elements with minimum energy loss.



0.8 MPa high working pressure

Suitable for high rise buildings and pressure pump applications. The multi function valve prevents pressure to increase beyond 8 bar.

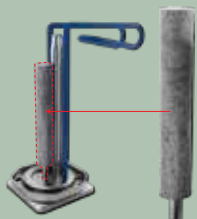

Anode rod protects tank from corrosion

The tank has an anode rod with a stainless steel core that is designed to protect the tank from corrosive elements. The system uses special catalyst action to fight the corrosive elements which in turn prolongs the life of the water heater.

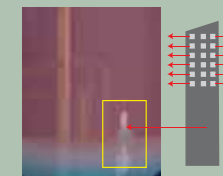

Whirlflow technology

It avoids direct contact between cold and hot water flow for a faster heating and optimized energy saving effecting 20% more hot water output.



Water resistance and splash proof (IPX-4)

Ensures high level of protection for electrical parts from water splashing

Presenting

the stunning & widest range
of Water Heaters

from Havells





1 L to 10 L
Instantio, Bianca &
Puro Turbo_Dx

KITCHEN



WATER HEATER SELECTION GUIDE

BATHROOM

15 L & Above

(A) Space is no constraint

Adonia, Bianca,
Monza DX & Monza Digi

(B) Space is constraint

Monza Slim, Monza DX-H

35 L & Above
Monza DX

SHOWER





PRESS SHOP

- Automatic hydraulic presses for deep drawing of steel sheets for making end covers of tanks
- Automatic robots for loading and unloading of press machines
- Automatic system ensures high productivity and consistency in parts

WELDING SHOP

- Best technologies from Japan ensure fool proof welding joints for years of trouble free service
- Welding of end caps and shells in an automatic MIG / Plasma welding line
- Each welded tank is tested for leakage at high pressure





FEROGLAS TECHNOLOGY

- Fully automatic shot blasting machine to remove impurities and oxides
- Swiss made fully automatic dry Feroglas coating machine
- Baking of coated tanks in PLC controlled, gas fired furnace for fusion of glass and 'steel, ensuring longer life.'

AUTOMATIC OUTER BODY ROLLING

- Most advanced outer body rolling with seamless welding system
- CNC controlled automatic punching machine
- Special purpose necking machine for precise bending
- State-of-the-art fully integrated pre-treatment and paint system





Adonia i

NEW



Capacity : 15 L & 25 L
Color : Ivory



Wi-Fi Control



Smart Scheduler



Convenient to use



Shock safe plug



Feroglas technology



Customer Alert



Geo Fencing



Multi-user control facility



Temperature sensitive LED indicators



Warranty

Model	A	B	C	D
Adonia i 15 L	390 mm	390 mm	358 mm	67.6 mm
Adonia i 25 L	453 mm	453 mm	394 mm	67.6 mm

- Amazon, Alexa and all related logos are trademarks of Amazon.com, Inc. or its affiliates.
- All trademarks used herein are property of their respective owners.
- Any use of third party trademarks is for identification purpose only and does not imply endorsement.
- Google is a trademark of Google LLC

Technical Dimensions: (in mm)

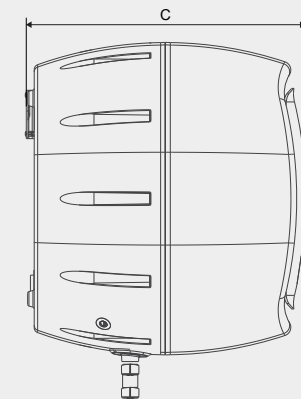
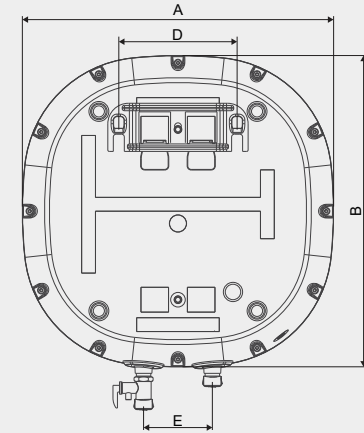



Monza Slim i



NEW

Capacity : 15 L & 25 L
Color : White Grey



Wi-Fi Control



Smart Scheduler



Convenient to use



Left and Right side configuration



Ferglas technology



Customer Alert



Geo Fencing



Multi-user control facility

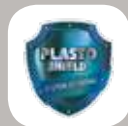

Plasto shield outer coating



Warranty

Technical Dimensions: (in mm)

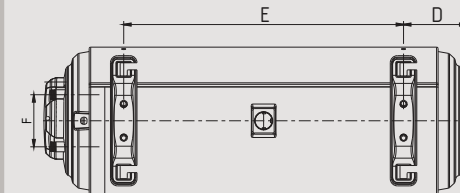
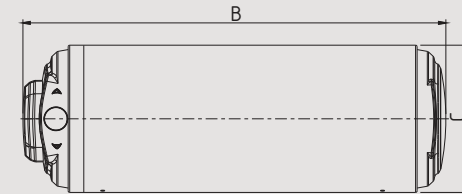
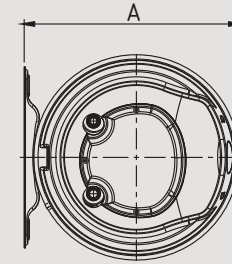

Model	A	B	C	D
Monza Slim i 15 L	325 mm	607 mm	311 mm	127 mm
Monza Slim i 25 L	325 mm	893 mm	311 mm	134 mm

- Amazon, Alexa and all related logos are trademarks of Amazon.com, Inc. or its affiliates.
- All trademarks used herein are property of their respective owners.
- Any use of third party trademarks is for identification purpose only and does not imply endorsement.
- Google is a trademark of Google LLC.



Adonia R



Capacity : 10 L, 15 L & 25 L
Color : White



Temperature sensitive LED indicators



Feather touch control panel



Hidden LED display



Shock safe plug



Ferglas technology



PUF insulation



0.8 MPa high working pressure



Incoloy glass coated heating element



Anode rod



Remote control for temperature setting



IPX-4 protection



Warranty

Model	A	B	C	D
Adonia R 10 L	390 mm	390 mm	319 mm	67.6 mm
Adonia R 15 L	390 mm	390 mm	358 mm	67.6 mm
Adonia R 25 L	453 mm	453 mm	394 mm	67.6 mm

Technical Dimensions: (in mm)

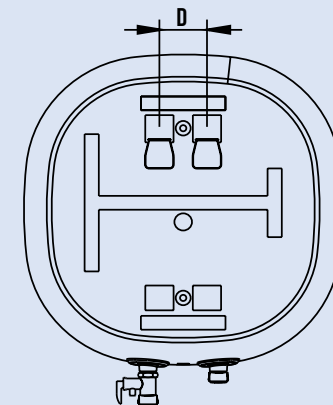
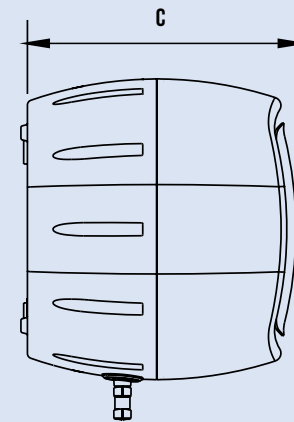
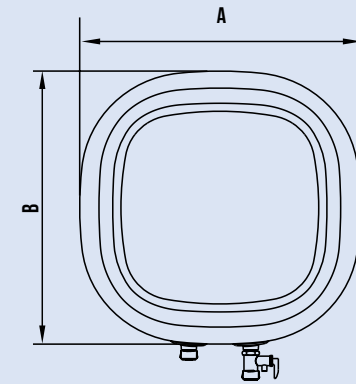



Bianca

NEW



Capacity : 10 L, 15 L & 25 L
 Colors : White Blue, Ivory Champagne Gold



Temperature sensing LED knob



Shock safe plug



Feroglas Technology



PUF insulation



Incoloy glass coated heating element



Anode rod



0.8 MPa high working pressure

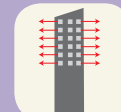

Whirlflow technology



IPX-4 protection



Warranty

Model	A	B	C	D
Bianca 10 L	412 mm	420 mm	280 mm	172 mm
Bianca 15 L	412 mm	420 mm	351 mm	172 mm
Bianca 25 L	466 mm	476 mm	388 mm	172 mm

Technical Dimensions: (in mm)

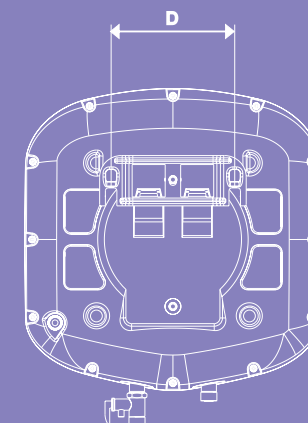
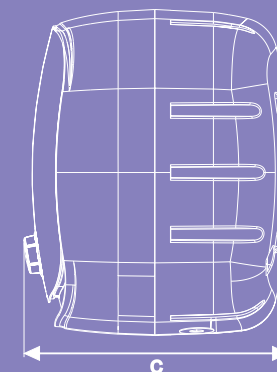
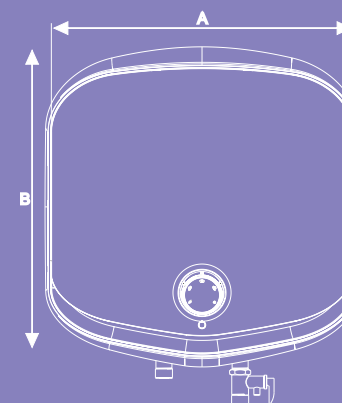



Puro Turbo DX



Capacity : 6 L, 10 L, 15 L & 25 L
Colors : White Blue, Ivory Pink

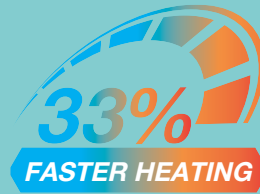

Turbo Mode
3 kW



Smart Mode
2 kW



Eco Mode
1 kW



Temperature
sensing LED knob



Shock
safe plug



Feroglas
Technology



PUF
insulation



Incoloy glass coated
heating element



Anode rod



0.8 MPa high
working pressure



Whirflow
technology



IPX-4
protection



Warranty

Technical Dimensions: (in mm)

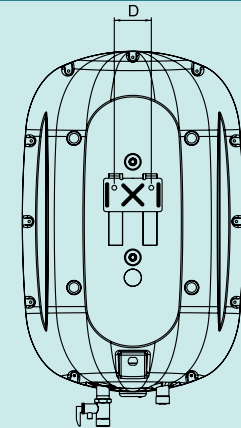
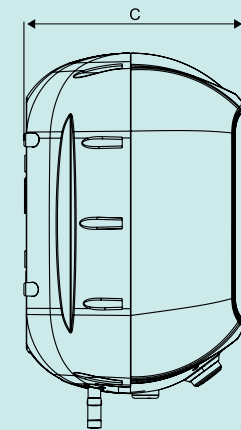
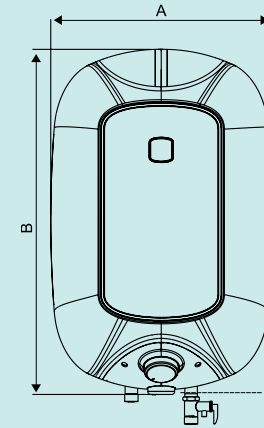

Model	A	B	C	D
Puro Turbo DX 6 L	271 mm	425 mm	258 mm	62 mm
Puro Turbo DX 10 L	318 mm	473 mm	304 mm	62 mm
Puro Turbo DX 15 L	329 mm	497 mm	330 mm	62 mm
Puro Turbo DX 25 L	370 mm	578 mm	370 mm	62 mm



Puro DX



Capacity : 10 L, 15 L & 25 L
Colors : White Blue, Ivory Pink



Temperature sensing LED knob



Shock safe plug

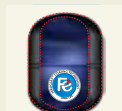

Feroglas Technology



PUF insulation



Incoloy glass coated heating element



Anode rod



0.8 MPa high working pressure

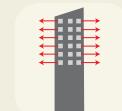

Whirlflow technology



IPX-4 protection



Warranty

Model	A	B	C	D
Puro DX 10 L	318 mm	473 mm	304 mm	62 mm
Puro DX 15 L	329 mm	497 mm	330 mm	62 mm
Puro DX 25 L	370 mm	578 mm	370 mm	62 mm

Technical Dimensions: (in mm)

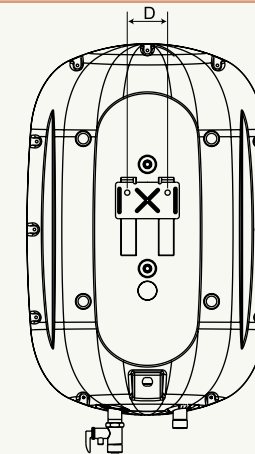
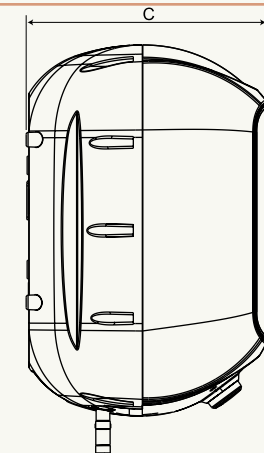
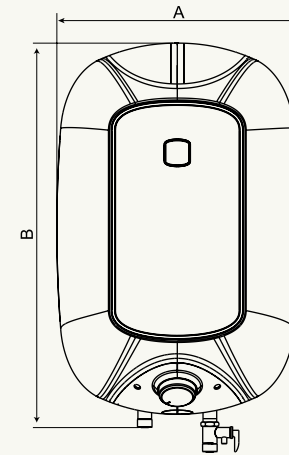



Puro EX



NEW



Capacity : 10 L, 15 L & 25 L
Colors : White Blue, Ivory Pink



Feroglas Technology



PUF insulation



Incoloy glass coated heating element



Anode rod



Adjustable temperature setting Knob



0.8 MPa high working pressure

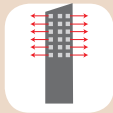

Whirflow technology



IPX-4 protection



Warranty

Model	A	B	C	D
Puro EX 10 L	318 mm	473 mm	304 mm	62 mm
Puro EX 15 L	329 mm	497 mm	330 mm	62 mm
Puro EX 25 L	370 mm	578 mm	370 mm	62 mm

Technical Dimensions: (in mm)

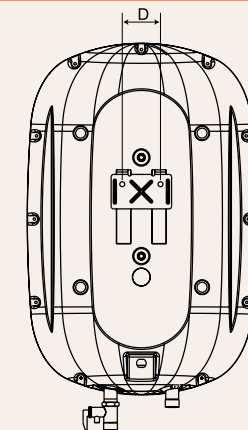
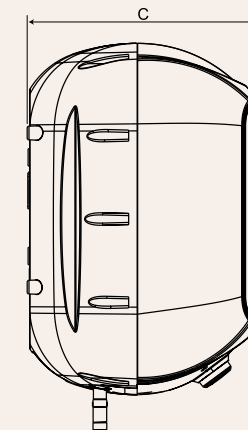
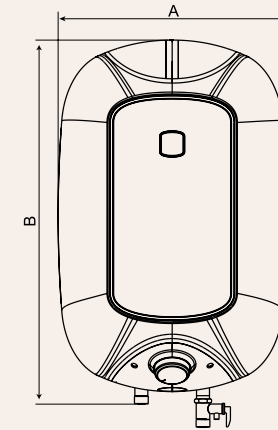



Instanio Prime



Capacity : 6 L
Colors : White Mustard, White Blue



Color Changing LED Indicator



Shock safe plug



Feroglas Technology



PUF insulation



Incoloy glass coated heating element



Anode rod



Whirlflow technology



0.8 MPa high working pressure



IPX-4 protection



Warranty

Model	A	B	C	D
Instanio Prime 6 L	260 mm	457 mm	254 mm	70 mm

Technical Dimensions: (in mm)

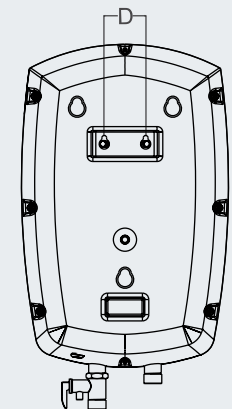
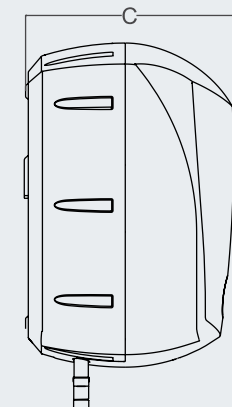
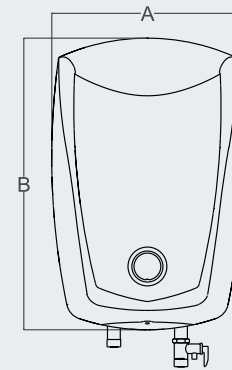



Monza Digi



Capacity : 10 L, 15 L & 25 L
 Colors : White - Grey, Ivory - Brown



Digital Display



Feather touch panel



Shock safe plug



Incoloy glass coated heating element



Anode rod



Ferrogas Technology



PUF insulation



0.8 MPa high working pressure

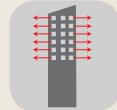

Whirlflow technology



Plasto shield outer coating



IPX-4 protection



Warranty

Model	A	B	C	D
Monza Digi 10 L	311 mm	440 mm	324 mm	217 mm
Monza Digi 15 L	311 mm	540 mm	324 mm	217 mm
Monza Digi 25 L	361 mm	620 mm	374 mm	217 mm

Technical Dimensions: (in mm)

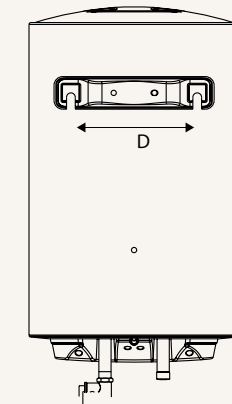
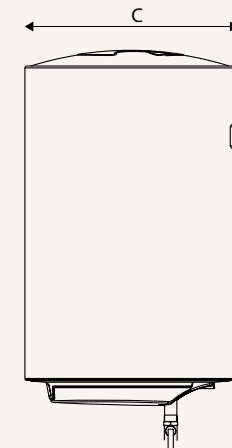
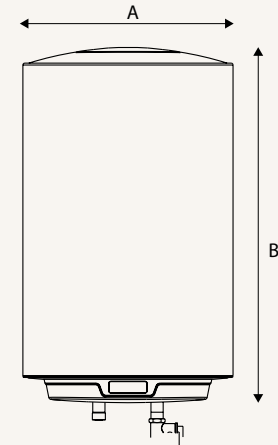



Monza DX



Capacity : 10 L , 15 L, 25 L, 35 L, 50 L & 100 L
 Colors : White - Grey, Ivory - Brown



Shock safe plug



Feroglas technology



PUF insulation



Incoloy glass coated heating element



Anode rod



0.8 MPa high working pressure

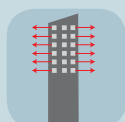

Whirlflow technology



Adjustable knob for temperature setting



Plasto shield outer coating



IPX-4 protection



Warranty

Model	A	B	C	D
MONZA DX 10 L	310 mm	462 mm	334 mm	217 mm
MONZA DX 15 L	310 mm	465 mm	334 mm	217 mm
MONZA DX 25 L	360 mm	625 mm	385 mm	217 mm
MONZA DX 35 L	411 mm	650 mm	435 mm	217 mm
MONZA DX 50 L	461 mm	652 mm	486 mm	217 mm
MONZA DX 100 L	461 mm	1070 mm	486 mm	217 mm

Technical Dimensions: (in mm)

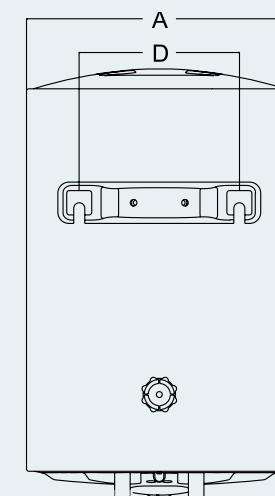
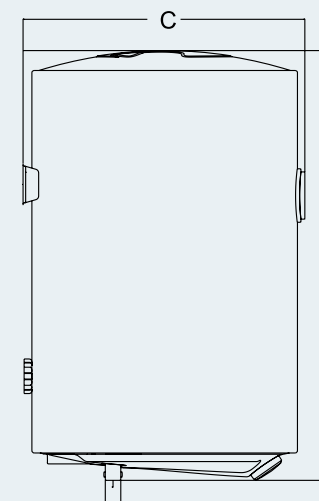



Troica NEW



Capacity : 10 L , 15 L & 25 L
 Colors : White - Grey, Ivory - Brown



Feroglas technology



PUF insulation



Incoloy glass coated heating element



Anode rod



0.8 MPa high working pressure



Whirlflow technology



Adjustable knob for temperature setting



Plasto shield outer coating



IPX-4 protection



Warranty

Technical Dimensions: (in mm)

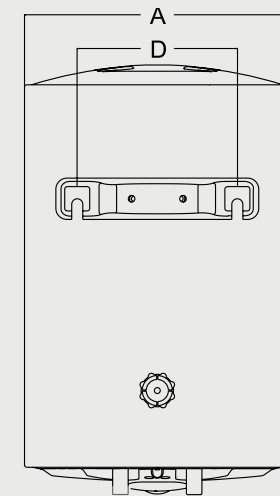
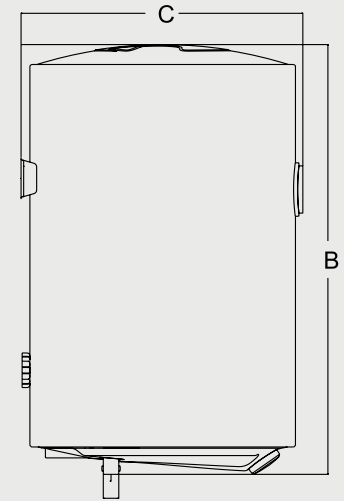

Model	A	B	C	D
TROICA 10 L	310 mm	412 mm	325 mm	217 mm
TROICA 15 L	310 mm	515 mm	325 mm	217 mm
TROICA 25 L	360 mm	575 mm	376 mm	217 mm



Monza DX H



Capacity : 35 L & 50 L
Color : White



Ferglas Technology



PUF insulation



Incoloy glass coated heating element



Anode rod



Adjustable knob for temp setting

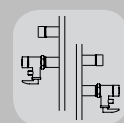

Left & right side configuration



Plasto shield outer coating



0.8 MPa high working pressure



Whirflow technology



IPX-4 protection



Warranty

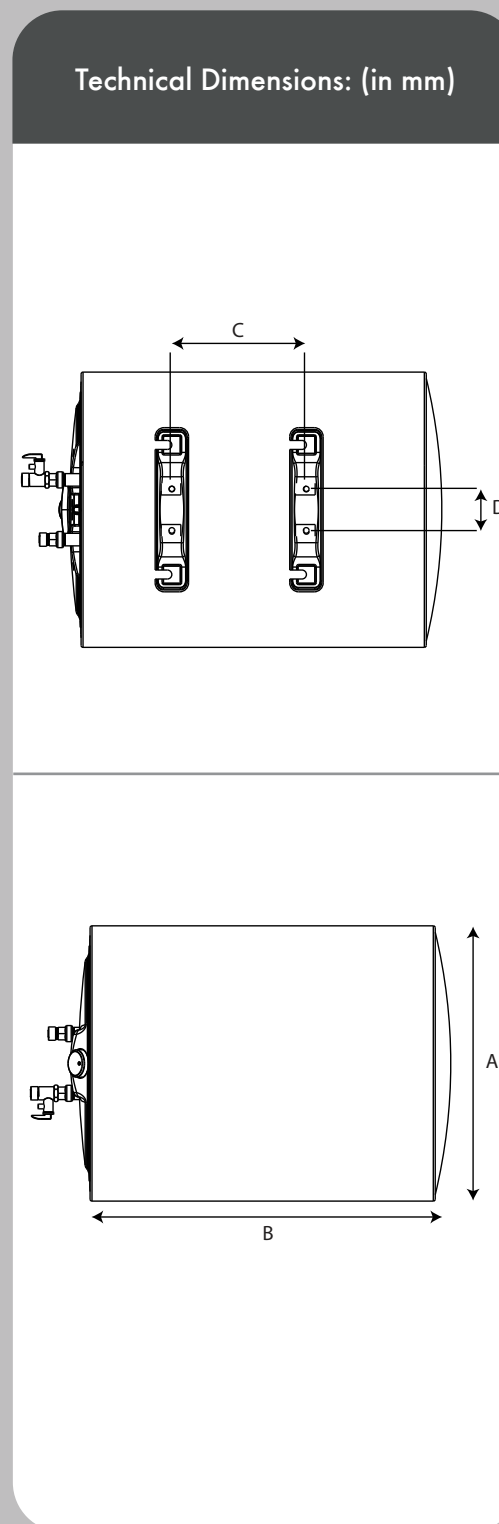

Model	A	B	C	D
MONZA DX - H 35 L	427 mm	662 mm	189 mm	217 mm
MONZA DX - H 50 L	477 mm	703 mm	217 mm	217 mm

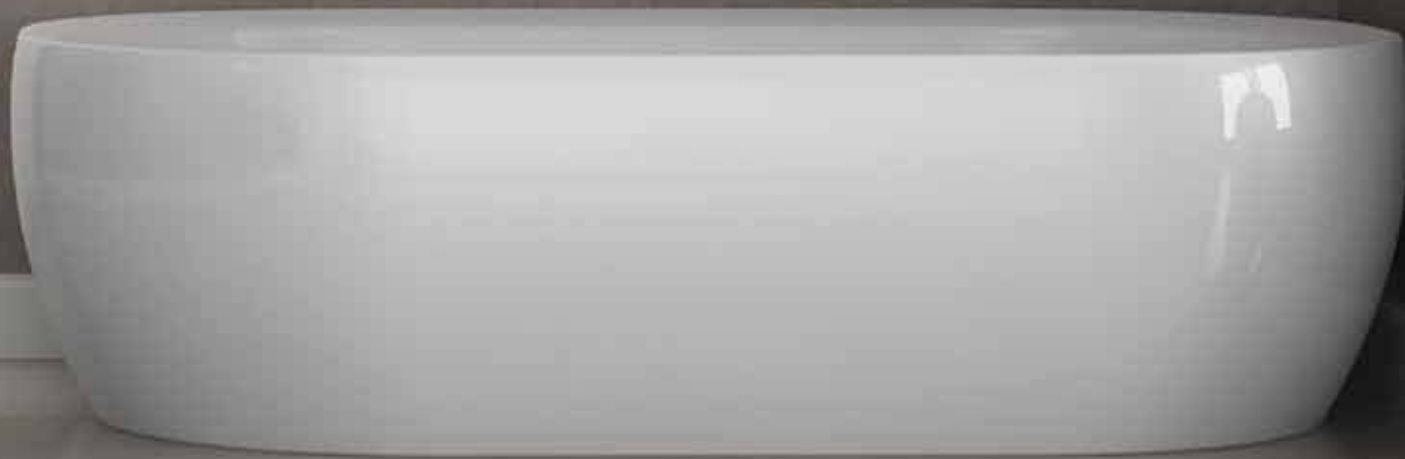
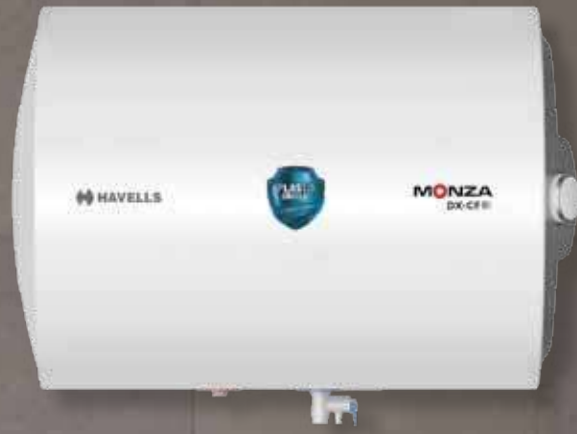

Monza DX CF NEW



Capacity : 50 L
Color : White



Feroglas Technology



PUF insulation



Incoloy glass coated heating element



Anode rod



Adjustable knob for temp setting



Plasto shield outer coating



0.8 MPa high working pressure



Whirflow technology



IPX-4 protection



Warranty

Model	A	B	C	D
Monza DX-CF 50 L	476 mm	600 mm	525 mm	217 mm

Technical Dimensions: (in mm)

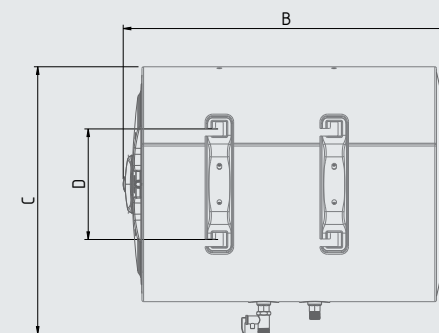
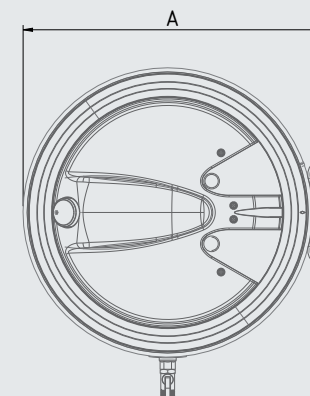



Monza Slim



Capacity : * 10 L, 15 L & 25 L
 Color : White Grey
 Mounting : Wall & Floor Mounting



Feroglas technology

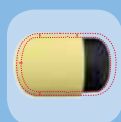

PUF insulation



Incoloy glass coated heating element



Anode rod



Adjustable knob for temperature setting

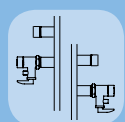

Left & right side configuration



Whirlflow technology



IPX-4 protection



Plasto shield outer coating



Warranty

Model	A	B	C	D
Monza Slim * 10 L	311 mm	473 mm	190 mm	217 mm
Monza Slim 15 L	311 mm	602 mm	320 mm	217 mm
Monza Slim 25 L	311 mm	875 mm	591 mm	217 mm

*Available in left / right side configuration.
 *10 L is only available on wall mounting.

Technical Dimensions: (in mm)

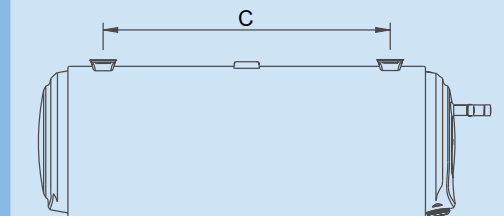
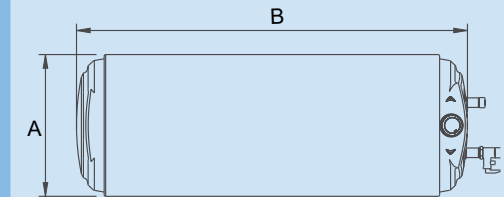



Instanio



Capacity : 1 L & 3 L*
 Colors : White Mustard, White Blue

White mustard color is only available in 3 L Capacity*



Color Changing LED Indicator



Rust & Shock Proof Outer Body



Stainless steel inner tank



Fire retardant power cord



0.65 MPa High working pressure



ISI Marked



Warranty

Model	A	B	C	D	E
Instanio 1 L	205 mm	294 mm	66 mm	184 mm	319 mm
Instanio 3 L*	225 mm	373 mm	66 mm	190 mm	345 mm

Technical Dimensions: (in mm)

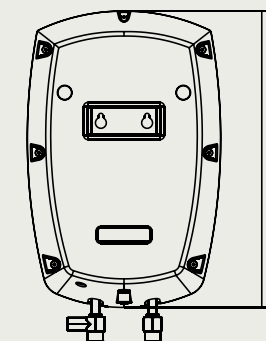
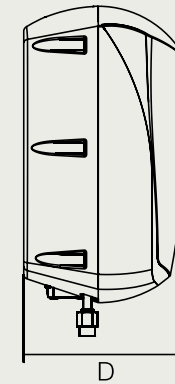
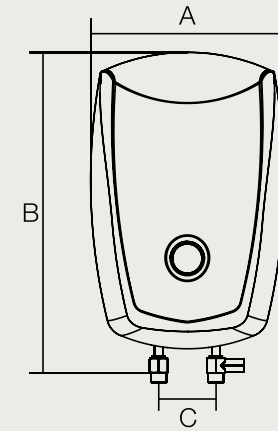



Renato

Instantaneous Electric Water Heater



Capacity : 3 L
Colors : White Blue, Ivory Brown



Rust & Shock
Proof Outer Body



0.65 MPa
High working
pressure



Twin indicator
for power &
heating



Fire retardant
power cord



Stainless steel
inner tank



ISI
Marked*



Warranty

Model	A	B	C	D	E
Renato 3 L	255 mm	373 mm	66 mm	194 mm	345 mm

Technical Dimensions: (in mm)

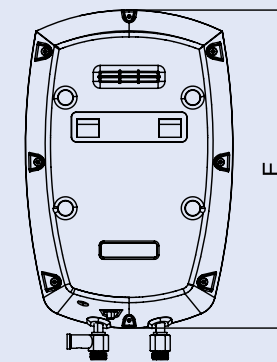
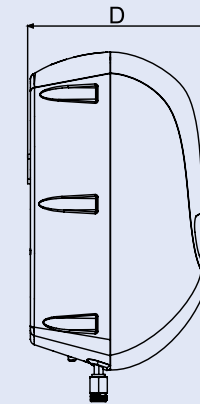
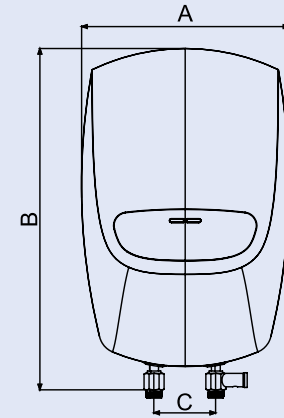



Opal



Capacity : 1 L & 3 L
 Color : White, Ivory*

Ivory color is only available in 3 L Capacity*



Rust & shock proof outer body



0.65 MPa High working pressure



Twin indicator for power & heating



Fire retardant power cord



Stainless steel inner tank



ISI Marked*



Warranty

Model	A	B	C	D	E
Opal 1 L	230 mm	326 mm	66 mm	210 mm	295 mm
Opal 3 L	250 mm	320 mm	60 mm	235 mm	335 mm

Technical Dimensions: (in mm)

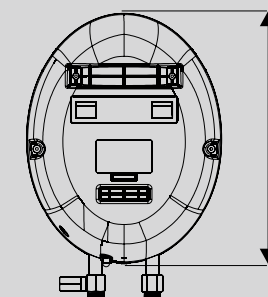
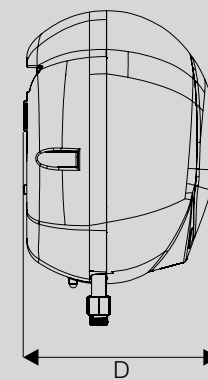
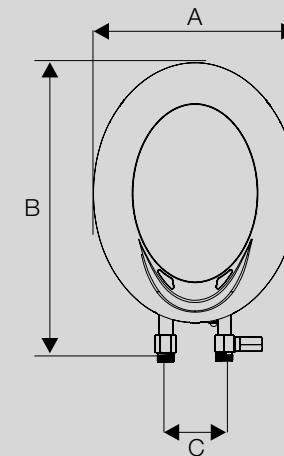



Flagro



Capacity : 6 L
Color : White



Dual electromagnetic Valve



Over heat protection



20 min timer protection



Anti-dry burning protection



Child lock safety device



Low water pressure protection



High water pressure protection



Flame out protection



Heat exchanger



Warranty



ISI Marked*

Technical Dimensions: (in mm)

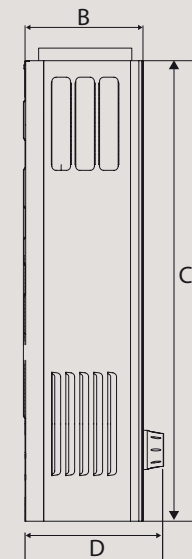
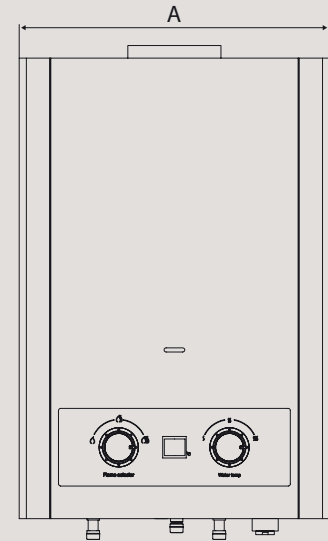

Model	A	B	C	D
Flagro 6 L	300 mm	120 mm	445 mm	140 mm

Available in LPG & NG



UPTO **70%**
ENERGY SAVING



Heat Pump

Now save energy with every bath



Capacity : 200 L & 300 L
Color : White Silver



Vitreous Enamel coated tank – Ideal for Hard water areas



Heavy duty magnesium anode rod for corrosion protection



Ultra-thick superior cold rolled steel tank for high pressure applications



High density 8 cm (80 mm) thick PUF insulation for maximum energy saving



Micro channel heat exchanger for efficient heating



Rated pressure of 0.8 MPa – Ideal for high rise buildings



Multi – functional safety valve



Smart Digital Controller for setting temperature with On & Off timer

Product Dimensions - Outdoor Unit			
Capacity	A	B	C
200 L & 300 L	790 mm	545 mm	546 mm

Product Dimensions - Indoor Unit			
Capacity	A	B	C
200 L	600 mm	1645 mm	1634 mm
300 L	650 mm	1570 mm	1560 mm

Note: All dimensions are in mm, dimensions tolerance ±5 mm

Technical Dimensions: (in mm)

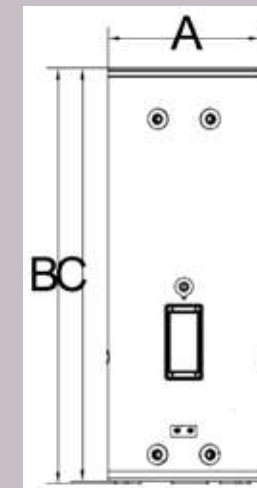
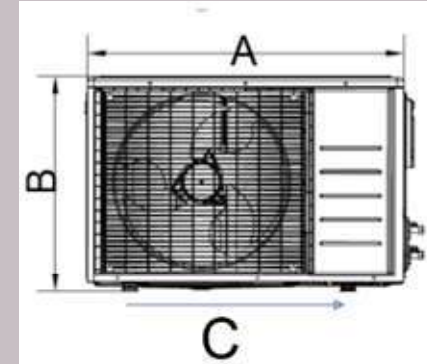



TECHNICAL INFORMATION

S. No. PARAMETER		Puro Turbo DX			
					
1	Rated capacity in L	6 L	10 L	15 L	25 L
2	Mounting	Vertical	Vertical	Vertical	Vertical
3	Rated voltage in V & frequency in Hz	230 V, 1 Phase 50 Hz AC			
4	Rated power input in W	3000 W	1000 W / 2000 W / 3000 W	1000 W / 2000 W / 3000 W	1000 W / 2000 W / 3000 W
5	Heating Element	Incoloy 800 glass coated			
6	Temperature sensing color changing ring LED knob	√	√	√	√
7	Shock Safe Plug	√	√	√	√
8	Rated input current in A	13 A	4.4 A / 8.7 A / 13 A	4.4 A / 8.7 A / 13 A	4.4 A / 8.7 A / 13 A
9	Thermostat cutout temperature (°C)	75 °C	75 °C	75 °C	75 °C
10	Rated pressure in MPa	0.8 MPa	0.8 MPa	0.8 MPa	0.8 MPa
11	Standing loss in kWh / 24 hours / 45 °C	0.291 kWh	0.365 kWh	0.419 kWh	0.511 kWh
12	Reheating time in minutes to raise 50 °C	11 min	12 min	16 min	30 min
13	Flexible pipe inside the box	√	√	√	√
14	Warranty				
	Inner container	7 Years	7 Years	7 Years	7 Years
	Heating Element	4 Years	4 Years	4 Years	4 Years
	Comprehensive	2 Years	2 Years	2 Years	2 Years
15	Water proof degree	IP X 4	IP X 4	IP X 4	IP X 4
16	Class of appliance	Class I	Class I	Class I	Class I

S. No. PARAMETER		Puro DX		
				
1	Rated capacity in L	10 L	15 L	25 L
2	Mounting	Vertical	Vertical	Vertical
3	Rated voltage in V & frequency in Hz	230 V, 1 Phase 50 Hz AC		
4	Rated power input in W	2000 W	2000 W	2000 W
5	Heating Element	Incoloy 800 glass coated		
6	Temperature sensing color changing ring LED knob	√	√	√
7	Shock Safe Plug	√	√	√
8	Rated input current in A	8.7 A	8.7 A	8.7 A
9	Thermostat cutout temperature (°C)	75 °C	75 °C	75 °C
10	Rated pressure in MPa	0.8 MPa	0.8 MPa	0.8 MPa
11	Standing loss in kWh / 24 hours / 45 °C	0.365 kWh	0.419 kWh	0.511 kWh
12	Reheating time in minutes to raise 50 °C	15 min	30 min	40 min
13	Warranty			
14	Flexible pipe inside the box	√	√	√
	Inner container	7 Years	7 Years	7 Years
	Heating Element	4 Years	4 Years	4 Years
	Comprehensive	2 Years	2 Years	2 Years
15	Water proof degree	IP X 4	IP X 4	IP X 4
16	Class of appliance	Class I	Class I	Class I



TECHNICAL INFORMATION

S. No. PARAMETER		Monza DX			Monza DX H	
						
1	Rated capacity in L	35 L	50 L	100 L	35 L	50 L
2	Mounting	Vertical	Vertical	Vertical	Horizontal	Horizontal
3	Rated voltage in V & frequency in Hz	230 V, 1 Phase 50 Hz AC				
4	Rated power input in W	2000 W	2000 W	3000 W	2000 W	2000 W
5	Heating Element	Incoloy 800 glass coated				
6	Shock Safe Plug	√	√	√	x	x
7	Rated input current in A	8.7 A	8.7 A	13.04 A	8.7 A	8.7 A
8	Thermostat cutout temperature (°C)	75 °C	75 °C	75 °C	75 °C	75 °C
9	Rated pressure in MPa	0.8 MPa	0.8 MPa	0.8 MPa	0.8 MPa	0.8 MPa
10	Standing loss in kWh / 24 hours / 45 °C	0.584 kWh	0.675 kWh	0.875 kWh	0.642 kWh	0.742 kWh
11	Reheating time in minutes to raise 50 °C	70 min	90 min	130 min	70 min	90 min
12	Flexible pipe inside the box	√	√	√	√	√
13	Warranty					
	Inner container	7 Years	7 Years	7 Years	7 Years	7 Years
	Heating Element	4 Years	4 Years	4 Years	4 Years	4 Years
	Comprehensive	2 Years	2 Years	2 Years	2 Years	2 Years
14	Water proof degree	IP X 4	IP X 4	IP X 4	IP X 4	IP X 4
15	Class of appliance	Class I	Class I	Class I	Class I	Class I

S. No. PARAMETER		Monza DX-CF	Monza Slim		
					
1	Rated Capacity In L	50 L	10 L	15 L	25 L
2	Mounting	Vertical Horizontal	Horizontal	Horizontal / Floor	Horizontal / Floor
3	Rated Voltage in V & Frequency in Hz	230 V, 1 Phase 50 Hz AC			
4	Rated Power Input in W	2000 W	2000 W	2000 W	2000 W
5	Heating Element	Incoloy glass coated	Incoloy glass coated		
6	Shock safe plug	x	x	x	x
7	Rated Input Current In A	8.7 A	8.7 A	8.7 A	8.7 A
8	Thermostat cutout temperature (°C)	75 °C	75 °C	75 °C	75 °C
9	Rated Pressure in MPa	0.8 MPa	0.8 MPa	0.8 MPa	0.8 MPa
10	Standing loss in kWh / 24 hours / 45 °C	0.742 kWh	0.401 kWh	0.461 kWh	0.562 kWh
11	Reheating time in minutes to raise 50 °C	90 min	15 min	20 min	35 min
12	Flexible pipe inside the box	√	√	√	√
13	Warranty				
	Inner Container	7 Years	7 Years	7 Years	7 Years
	Heating Element	4 Years	4 Years	4 Years	4 Years
	Comprehensive	2 Years	2 Years	2 Years	2 Years
14	Water Proof Degree	IP X 4	IP X 4	IP X 4	IP X 4
15	Class of Appliances	Class I	Class I	Class I	Class I

TECHNICAL INFORMATION

S. No. PARAMETER		Instanio			
					
1	Rated capacity in L	1 L	1 L	3 L	3 L
2	Mounting	Vertical	Vertical	Vertical	Vertical
3	Rated voltage in V & frequency in Hz	230 V, 1 Phase 50 Hz AC			
4	Rated power input in W	3000 W	4500 W	3000 W	4500 W
5	Heating Element	Heavy duty copper element			
6	Rated input current in A	16 A	25 A	16 A	25 A
7	Thermostat cutout temperature (°C)	55 °C	55 °C	55 °C	55 °C
8	Rated pressure in MPa	0.65 MPa	0.65 MPa	0.65 MPa	0.65 MPa
9	Flexible pipe inside the box	√	√	√	√
10	Warranty				
	Inner container	5 Years	5 Years	5 Years	5 Years
	Heating Element	2 Years	2 Years	2 Years	2 Years
	Comprehensive	2 Years	2 Years	2 Years	2 Years
11	Class of appliance	Class 1	Class 1	Class 1	Class 1

S. No. PARAMETER		Renato	Opal			
						
1	Rated capacity in L	3 L	1 L	1 L	3 L	3 L
2	Mounting	Vertical	Vertical	Vertical	Vertical	Vertical
3	Rated voltage in V & frequency in Hz	230 V, 1 Phase 50 Hz AC				
4	Rated power input in W	3000 W	3000 W	4500 W	3000 W	4500 W
5	Heating Element	Heavy duty copper element				
6	Rated input current in A	16 A	16 A	25 A	16 A	25 A
7	Thermostat cutout temperature (°C)	55 °C	55 °C	55 °C	55 °C	55 °C
8	Rated pressure in MPa	0.65 MPa	0.65 MPa	0.65 MPa	0.65 MPa	0.65 MPa
9	Flexible pipe inside the box	√	x	x	√	√
10	Warranty					
	Inner container	5 Years	5 Years	5 Years	5 Years	5 Years
	Heating Element	2 Years	2 Years	2 Years	2 Years	2 Years
	Comprehensive	2 Years	2 Years	2 Years	2 Years	2 Years
11	Class of appliance	Class 1	Class 1	Class 1	Class 1	Class 1

S. No.	Model	HHP20 (200 L)	HHP30 (300 L)	
				
1	Power Supply	200 V ~ 240 V /~ 50 Hz	200 V ~ 240 V /~ 50 Hz	
2	Electric Shock Proof Grade	Class I	Class	
3	Water Proof Level	IPX 4	IPX 4	
4	Heat Pump	Rated Heating Capacity	2600 W	2600 W
		Heating Input Power	650 W	650 W
		Heating Input Current	2.88 A	2.88 A
		Water Yield	56 L / h	56 L / h
		COP (W/W)	4	4
		Rated Power Input	1000 W	1000 W
5	Electric Heater	Rated Current	4.5 A	4.5 A
		Type	Electric Heater	Electric Heater
		Rated Power Input	2000 W	2000 W
		Rated Current	9.1 A	9.1 A
6	Default Water Outlet Temperature		55 °C	55 °C
7	Max. Water Outlet Temperature With Electric Heater		75 °C	75 °C
8	Unit Working Condition		-7 °C ~43 °C	-7 °C ~ 43 °C
9	Unit Working Condition With Electric Heater		-20 °C ~ 43 °C	-20 °C ~ 43 °C
10	Refrigerant / Weight		R 134 a / 0.9 kg	R 134 a / 0.9 kg
11	Noise		52 dB	52 dB
12	Rated Current		13.6 A	13.6 A
13	Max. High Pressure		2.6 MPa	2.6 MPa
14	Max. Low Pressure		1.3 MPa	1.3 MPa
15	Water Tank Rated Pressure		0.8 MPa	0.8 MPa
16	Water Tank Max. Pressure		1 MPa	1 MPa
17	Warranty			
	Inner Container		5 years	5 years
	Compressor		5 years	5 years
	Comprehensive		2 years	2 years

All dimensions in “mm” provided in charts refers to the corresponding mechanical figures in this document.

Copyright Subsists. Imitation of trade dress, graphics and color scheme of this document is a punishable offence.

E & OE. Pictures and details of the product(s) in this document are merely illustrative.
Actual products may vary in colour, design, description and colour combination etc.



HAVELLS

buy online* at **shop.havells.com**

*Online shopping is applicable on select products.